Cambridge White Spaces Consortium
Cambridge TV White Spaces Trial
A Summary of the Technical Findings



Contents

1	Executive Summary	5
1.1	Foreword	7
<hr/>		
2	Overview of TV white spaces	9
2.1	What are white spaces?	9
2.2	Coverage and throughput potential	10
2.3	White Spaces across Europe	11
2.4	Working together in Europe	11
<hr/>		
3	The purpose and structure of the trial	12
3.1	Introduction	12
3.2	Aims and objectives	12
3.3	Introduction to the supporting partners	13
3.4	The Cambridge test bed network	13
3.4.1	Overview	13
3.4.2	Base station commissioning process	14
3.4.3	City base stations	14
3.4.4	Rural/Semi-rural base stations at member company sites	15
3.4.5	TV white spaces radios used	15
<hr/>		
4	Achieving the trial's objectives – overview of the test and measurement programme	16
4.1	Introduction	16
4.2	The Art of Interference Protection	16
4.3	Ofcom's proposals for protection of licensed services	16
4.4	How the trial addressed Ofcom's needs	17
4.4.1	Protection ratios and coupling factors	17
4.4.2	Statistical approaches to refining DTT protection	17
4.5	The suitability of TVWS for new services and applications	18
4.5.1	Evaluating White Spaces Base station coverage	18
4.5.2	Evaluating the white spaces around Cambridge	18
4.5.3	Estimator for white space availability	18
4.5.4	Evaluating coverage and performance of a white space base station	18
4.5.5	A rural broadband application	18
4.5.6	An urban broadband application	18

5	Results – characteristics of TVWS signals and spectrum	19
5.1	Cambridge TVWS signal distribution patterns	19
5.1.1	Description	19
5.1.2	Findings	19
5.2	General spectrum survey over time of all UHF activity	20
5.2.1	Description of survey platform	20
5.2.2	Survey results	21
5.3	Estimating the TV white spaces capacity in Cambridge based on postcode entry and UKPM data	22
5.3.1	TVWS spectrum estimator based on postcode entry and UKPM data	23
5.4	TVWS link performance survey	24
5.4.1	Description and background	24
5.4.2	Results	26
5.5	Rural Broadband link measurements, findings and analysis	27
5.5.1	Background	27
5.5.2	Trial Description	27
5.5.3	Findings	28
5.5.4	Analysis and Conclusions	28

6	Results – reviewing Ofcom’s proposed protection requirements for DTT	30
6.1	Field measurements of DTT path losses /coupling factors	30
6.1.1	Aims and description	30
6.1.2	Results	30
6.2	Bench measurements of thresholds for interference from TVWS signals with a representative selection of DTT receivers	31
6.2.1	Description and background	31
6.2.2	Results	31
6.3	The complexity of RF propagation and application of statistical techniques	33
6.4	Assisting with Ofcom’s protection requirements for PMSE	34
6.4.1	Description and background	34
6.4.2	Results	35

Contents

7	Summary of findings and recommendations	37
7.1	Review and analysis of the key findings	37
7.1.1	Headlines	37
7.1.2	TVWS applications	37
7.1.3	Coexistence of TVWS with DTT and PMSE	37
7.1.4	Developments outside the trial – standards and other trials	39
7.2	Recommendations arising from the technical work carried out in the Cambridge trial	39

8 Appendix 41

8.1	Glossary of acronyms	41
8.2	A message of acknowledgement to the members of the test and measurement work strand	41
8.3	An overview of standards activities relating to TVWS	41
8.4	References	42
	• List of associated, more detailed technical reports carried out by members	42
	• Other useful source of information	42

1 Executive Summary

The Cambridge White Spaces Trial was designed to help Ofcom translate its proposals for licence-exempt access to white space spectrum into a secure enabling framework which protects the licensed services as well as allowing innovation. It was also intended to help illustrate the potential for white spaces to service a number of key applications.

To assist Ofcom's development of the enabling framework, the trial included a number of in-depth test and measurement projects, focussing on the protection requirements for the existing services.

To help industry understand the application potential of television white space spectrum, the trial included work to demonstrate the feasibility of using TV White Spaces (TVWS) technology including sample applications in a number of key categories.

The programme covering protection requirements made several important findings with regard to elements needed in the geolocation database that will facilitate white space applications. These elements included reference geometries, coupling factors and protection ratios for protecting digital terrestrial television.

Consideration was also given to the role of statistical techniques in refining the operation of the geolocation database such that excess protection for Digital Terrestrial Television (DTT), which would damage the prospects for white space applications, might be mitigated. The adoption of these techniques would be subject to practical validation.

Practical tests on Programme Making and Special Events (PMSE) equipment¹ were carried out in a theatre to assess the susceptibility of this important service to white space emissions.

Spectrum sweep measurements were made to check that spectrum usage was as expected, detecting both the existing digital terrestrial television service and the trial's white space emissions.

The recommendations flowing from these tests are included below.

Some typical white space applications were successfully tested using white space equipment from two vendors:

- A rural link as an alternative to DSL / fibre.
- Wireless backhaul of a Wi-Fi hotspot in a city centre environment.

The coverage and range of these applications were as predicted, and as expected, was vastly superior to that which could be expected from existing Wi-Fi frequencies and power levels. These are by no means the only applications planned for white spaces, and the trial also successfully demonstrated the technology of a vendor planning to provide machine to machine connectivity, also known as "The Internet of Things".

Some further recommendations from the application tested are also included below.

The overall finding of the programme was that TVWS technology can and will work to deliver services that are attractive to consumers, beneficial to UK plc and will help to meet government objectives in reducing the digital divide. Furthermore, through detailed bench and field work, the trial has demonstrated the successful coexistence of TVWS with the incumbent services, in a number of defined scenarios within constraints on transmission power that arose largely from the capabilities of the available TVWS radios and installation requirements (long feeder cables were needed). However, the studies conducted within these constrained circumstances

¹Which includes devices such as wireless microphones and in-ear monitors

have helped to define and in some cases propose new frameworks which should ensure that TVWS applications can be deployed more generally in a broader range of scenarios and with potentially higher transmission power, where this can be achieved without impairing the incumbent services.

The trial's key findings and recommendations are as follows:

- Members of the consortium have successfully demonstrated the value that TVWS can contribute to a number of key applications within the Trial, including rural broadband provision, city broadband coverage enhancement, machine to machine applications and location-based services. Administrations and regulators should recognise the economic and social value which TV white spaces and database-enabled spectrum access could facilitate, though improving efficiency of spectrum use.
- The trial has successfully tested several of the important concepts and techniques that are required for TV white space devices to co-exist with the licensed services – namely digital television and PMSE. Given the use of a database to enable TV white space spectrum access, any changes arising from the evolution of market requirements and technology advances can easily be accommodated. Administrations should expeditiously develop and implement regulations that enable consumers to benefit from the new applications of TVWS, whilst ensuring that co-existence with incumbent services is adequately catered for.
- Administrations should take note of the adjustment to the reference geometry for DTT protection from TVWS mobile devices recommended out of Arqiva's field tests. They should also take note of Arqiva's recommendation to further consider how uncertainty in the separation between a roof top TVWS antenna and a DTT antenna can be managed such that impairment of DTT reception is avoided.
- Administrations should ensure that protection ratios and coupling factors used in the geolocation database are up to date and representative of equipment in the field. Each new candidate White Space Device (WSD) technology will require a comprehensive programme of testing to evaluate the appropriate protection ratios for the database. These protection ratios will also depend on the emissions masks chosen by industry and ETSI. Tighter masks would enable an improved power/spectrum availability trade-off.
- Administrations should encourage the continuous development of WSDs, DTT and PMSE equipment to ensure that technology opportunities for increasing the efficiency of spectrum use are exploited. Industry must also play its part.
- Administrations should allow multiple TV white spaces device profiles for use by the database, including support for roof-top, mobile, and indoor fixed deployments, and require the minimum necessary power to be used. The permitted WSD emission power will be a function of the WSD technology, Adjacent Channel Leakage Ratio (ACLR) mask and interference characteristics established through protection ratio measurements. If administrations decide to protect indoor antenna reception as well as fixed reception, studies show that some spectrum is still likely to be available for TVWS applications but higher power WS devices would need to be kept clear of populated areas.
- Administrations should investigate and where possible, test the benefits of statistically modelling the assumptions and variables used in the geolocation database. Where appropriate, factors should be incorporated into the geolocation database to ensure that interference mitigation is proportionate and not wholly based on a combination of worst case reference geometries, coupling factors and protection ratios. A successful balance would provide

sufficient protection for incumbents and at the same time, enable higher power WSD applications. Administrations should ensure that PMSE users have adequate protection from harmful interference. In particular, the geolocation database should be used to prevent co-channel frequency allocations to TVWS devices within the specific site of a PMSE allocation. Consideration of intermodulation distortion and WSD IMD performance may also be required, in determining available channels and WSD emission limits in the vicinity of PMSE venues.

- Administrations should encourage the use of PMSE conforming to professional standards by limiting protection to the level required by products that meet those standards.
- Guidelines should be produced for PMSE users such that interference from WSDs operating on adjacent channels can be prevented by ensuring minimum separation safeguards between WSD and PMSE transmit and receive equipment similar to those found in the trial. In the case of multi-channel PMSE systems, it seems likely that a separation of a few metres will be required between a WSD and any radio microphone that is part of that system. The trial consortium understands that further tests are being undertaken² to validate and elaborate on these findings as WSD technology develops.
- Spectrum monitoring can have a role to play in establishing the efficient use of spectrum by increasing the transparency of its use – both authorized and unauthorized. Real-time networks of low-cost monitoring nodes could help white space applications to optimize the selection and use of channels indicated as available by a geolocation database. Administrations should recognise the value of spectrum monitoring and consider promoting its use as part of a progressive approach to managing spectrum more efficiently.

1.1 Foreword

Since the launch of the first colour television services in the 1960s, the UHF bands have witnessed a succession of major innovations, bringing significant benefits for consumers and providing considerable economic and cultural value, across the world. In the UK, colour services were followed by Teletext, which was in turn followed by NICAM stereo sound, in the early 90s. Then, in 1998 the first digital terrestrial services arrived, bringing more than six fold increase of television channels to choose from. At each juncture, engineers carefully weighed up the potential impact of new technologies on the older established services and worked to minimise any negative impact. Now, into the second decade of the third millennium, consumers are rapidly acquiring a taste for interactive services alongside traditional broadcast television – dubbed ‘Connected TV’ and on-demand viewing. The growing appetite for these and a host of other online services covering a wide range of needs, has intensified the search for further opportunities to enrich the UHF payload.

The Cambridge White Spaces Trial was established in June 2011 by eleven leading companies in the Communications sector, to look at the potential of new technology to allow licence-exempt sharing of the UHF bands and thereby facilitate a host of new services and applications. Specifically the companies which established the consortium behind the trial³ wanted to help Ofcom develop its cognitive access proposals into a robust but flexible sharing framework. The resulting legislation should protect the licensed services whilst creating opportunities for innovation and helping to fulfil key political objectives, such as extending the benefits of broadband to even the most remote rural communities. The companies also wanted to use the opportunities created by the trial to improve their understanding of the commercial potential from the dynamic, flexible access which the new television white spaces (TVWS) technology can facilitate.

² Ofcom was given full access to the tests and test data produced within the trial and is reported to be carrying out further tests at Baldock.

³ The Cambridge White Spaces Consortium grew from the original eleven members and now includes: Adaptrum, Alcatel-Lucent, Arqiva, BBC, BSkyB, BT, Cambridge Consultants, CRFS, CSR, Digital TV Group (DTG), Microsoft, Neul, Nokia, Samsung, Spectrum Bridge, TTP and Virgin Media.

The objectives given here were achieved by a combination of implementing a set of key potential applications and an in-depth measurement programme to better understand what capability the new technology provides as well as the protection which existing services would need around such deployments.

The depth and extent of the test and measurement activities encompassed in this trial bear witness to the professionalism of the supporting companies and the remarkable degree of commitment and cooperation they showed – setting aside their apparently significant different commercial interests in how UHF (Band IV/V) spectrum is exploited. The consortium's mutual aim was to increase the industry's understanding of how co-existence can be achieved between TVWS technology and the incumbent users of UHF (i.e. the broadcasters and PMSE users) and to provide this information to regulators who are presently forming the enabling legal framework.

The trial has been running in parallel with a separate but closely related activity in the CEPT SE 43 working group. This working group is looking specifically at co-existence between TVWS and the incumbent applications including DTT and PMSE, but with a pan-European perspective. CEPT SE 43 documents are excellent resources for those working in this field and are available for downloading, free of charge. They include highly valued analyses provided by Cambridge consortium members.

2 Overview of TV white spaces

2.1 What are white spaces?

Television white spaces (TVWS) are pockets of spectrum which are not being used for the delivery of television services in a given geographic area. These pockets vary in number and frequency from one location to another, as a result of the way terrestrial television networks have been planned. Over the decades, regulators have responded to consumer demand for more services by harvesting the most attractive white spaces – where coverage is still cost effective for broadcast television. Traditionally, the white spaces have only been used by PMSE applications, on a licensed basis, but other applications could also share this spectrum – a selection of which has been demonstrated in the Cambridge Trial.

In the UK and Europe, terrestrial television services are distributed on a national or regional basis. There have been a few city-wide channels, but these are exceptions. In the UK, television services are distributed using a multi-frequency network, meaning that a service is transmitted on different frequencies in different parts of the country, enabling the support of regional services⁴. UK coverage for a television service is like a patchwork quilt, in frequency terms: it works provided that different frequencies are used for a given service in adjacent service areas – otherwise, harmful interference would occur at the overlap. At each transmitter site, only a fraction of the available UHF channels are needed to provide the required services for the area served by that transmitter. For example, around Cambridge most of the population is served by a single transmitter, at Sandy Heath, which uses just six UHF channels to deliver the full digital terrestrial television bouquet (all of the Freeview Channels). In principle, the other [26] channels allocated for broadcasting in the UK are white space within Sandy Heath’s coverage area⁵.

This spectrum reuse is illustrated on the following map, showing the television coverage provided using channel 22 (482 MHz). The gaps between the DTT coverage areas (shown in black) illustrate where channel 22 would, in principle, be available to TVWS applications. The WSD transmit power permissible in these gaps varies with location, as indicated by the colours on the map: warm colours correspond to higher powers and cooler colours indicate lower power. Accessing this fragmented spectrum requires knowledge of location and the surrounding DTT network.

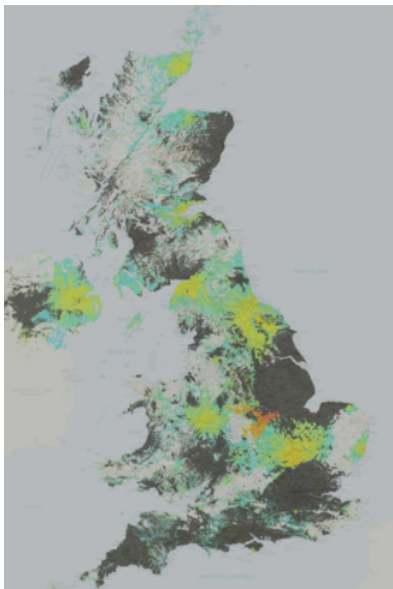

Figure 01: Use of Channel 22 – showing protected areas in black and permissible WSD power levels in varying shades

© Crown copyright and database rights 2011 Ordnance Survey 100039117

⁴Digital television transmission technology also supports what is known as a single frequency network (SFN) for terrestrial distribution, however this places constraints on the physical configuration of the network and requires content to be identical across all transmitters in the network – this is typically not the case in the UK for most PSB services.

⁵At the edge of Sandy Heath’s coverage, some of the “white space channels” will be in use by neighbouring transmitters for adjacent regions. These need to be taken into account in populating the geolocation database and estimating available white space capacity more accurately.

In more hilly areas, planners often need more transmitters to achieve the coverage. This results in potentially overlapping coverage from a number of transmitters in order to ensure that all households have an opportunity to receive the full complement of television services⁶. In these areas, many more channels may be needed for television service distribution for a given land area. In the UK, Ofcom has explored how spectrum efficiency could be increased, by dividing the country into a large number of cells and then determining which transmitter would be the predominant source of coverage in each [100 m²] cell⁷ known as a pixel. The regulator could then designate the channels used by this transmitter as the 'preferred service' within that pixel and all other channels could be made available for white space applications, albeit with varying levels of background noise and interference – for example from distant, "non-preferred" DTT transmitters. The BBC made use of this assumption, that only services from the 'preferred' transmitter(s) need be protected, in calculating white space availability across the UK. This formed part of its contribution to the Cambridge Trial. This approach releases more white space, but the spectrum is subject to interference from the unprotected DTT transmissions and needs to be considered in determining its value to potential new applications.

2.2 Coverage and throughput potential

White space networks can benefit from the excellent propagation available in the UHF bands. The lower the frequency used, the greater the range that can be achieved for a given transmission power level⁸. At any given location, the number of channels usable by white spaces applications is a function of the transmission power needed by those applications. The lower the power an application requires, and the more isolated it is from TV receiving antennas, the more channels that could be made available to meet its needs. Low power indoor white spaces applications such as home networking, for example, could be expected to find many more usable channels than higher power applications using high external antennas.

Not all white space spectrum, unused for DTT, is available to use in all locations at all times. There are many theatres, studios and other venues where wireless microphones are licensed to use white spaces during at least certain defined times of the day⁹. These users take priority over the new applications and must be protected by the white spaces regulatory framework.

The actual coverage/throughput combination that can be achieved is a function of a number of key variables:

1. The transmission power that a white space device will be allowed to use will be determined by the regulator for the given location and channel combination – and will be communicated to the device via a geolocation database. This, in turn, will be determined by the regulator's assumptions on:
 - a. How much protection DTT and PMSE services in adjacent channels require, given the type of white space device transmissions and the frequency separation.
 - b. The signal level of the protected services in the given location
 - c. How much the white space device's emissions will be attenuated by, at the antenna of the receiver for the protected service – whether television or a wireless microphone application.
 - d. The directivity and orientation of the TVWS device antenna and the antenna gain of the protected services in the direction of the TVWS device, and any polarization discrimination.
2. The height and gain (directionality) of the base station and client antennas

⁶ In the UK, television service planners had a target of 98.5 % of households for the public service broadcasters – BBC, ITV, Channel 4 and Five.

⁷ One of the reports commissioned by Ofcom on this topic may be found at: <http://stakeholders.ofcom.org.uk/binaries/consultations/ddd/statement/NGW1.pdf>

⁸ Subject to the noise and interference level prevailing at the given location, e.g. from DTT.

⁹ There are also temporary venues, often outdoors, for sporting events such as golf matches. These are typically licensed for particular days in the year around the location of the venue.

3. The frequency. Applications using white space channels in the lower part of the UHF bands enjoy improved propagation compared with those in the upper part of the bands
4. The nature of the ‘clutter’ between base station and its client or clients, which can lead to varying levels of absorption of the signals
5. The level of interference and noise that is present in the given channel – arising, for example, from distant television transmitters operating on the same channel. The higher the level of interference and noise, the lower the margin available for white spaces applications. This is driven largely by terrestrial television planning and is not directly in the gift of individual national regulators. However white space device manufacturers are looking at how some of the effects of interference might be mitigated and therefore performance enhanced.

Within these constraints, white space networks can trade off coverage for increased performance, by configuring the modulation and error protection used. For example, in remote rural areas where user density is low, it might be desirable to enhance coverage at the expense of throughput, by using a more robust channel encoding.

2.3 White Spaces across Europe

Across Europe, many television stations need to be accommodated in the UHF bands. Fitting in the required number of television services requires intensive reuse of the 39 UHF channels (8 MHz wide) currently allocated for broadcasting across Europe.

Television service coverage areas frequently cross national borders. Although, neighbouring countries cannot use the spectrum occupied by foreign channels, the spectrum could be made available for white space applications – albeit that the interference levels may be higher than in other white space channels.

2.4 Working together in Europe

Because the signals from high power television transmitters propagate a long way, countries need to cooperate with their neighbours when planning terrestrial television coverage. In the Regional Radio Conference in Geneva, in 2006, representatives from around 120 countries met to work out how they could make use of the then 48 available UHF channels to replace analogue television services with between 7 and 8 multiplexes per country for digital television broadcasting. The result was a blueprint for digital switchover – though it has been revised since, to take account of regulators’ desire to free capacity for mobile broadband and voice services.

The ‘Geneva 2006’ plan left a considerable quantity of white spaces, to protect the planned services from interfering with each other. Some countries only planned to use a subset of their allocation for broadcasting. For example, the UK’s requirement was for sufficient spectrum for six multiplexes, to meet its existing broadcasting needs – the remaining capacity could be planned and auctioned as ‘Digital Dividend’. Some other countries planned somewhat larger digital television bouquets with up to 11 or more multiplexes – which would tend to reduce the available white spaces. However, European Commission actions to mandate a digital dividend, together with weaker than expected commercial demand for terrestrial television multiplex capacity, has led to reconsideration of plans for spectrum use across the continent.

3 The purpose and structure of the trial

3.1 Introduction

Wireless connectivity has never been in such great demand. Mobile broadband and wireless access to the Internet are in the forefront, but there is a wide range of other applications. This demand has been fed by advances in communication technology and devices which render access to new services in a way that previous generations could only have dreamt of. The increasing wireless freedom, which consumers have now come to expect, places a burden on network infrastructure. Operators are bringing optical fibre closer to customers, to deliver superfast broadband speeds, but wireless has an increasing role in bringing access to the growing range of connected consumer devices. New technology and the use of smaller cells both help to make better use of existing spectrum allocations to improve the performance that wireless networks deliver, but it will also be necessary to add spectrum capacity.

Regulators have scoured the bands for opportunities to free up spectrum from older technologies, for new wireless networks. However whilst this work is vital, it is a slow and costly task. Another approach gaining support is to share spectrum more intensely, for example through dynamic spectrum access techniques. Such sharing could also enable a wide range of other applications and innovations, which might otherwise struggle to access spectrum and reach the market.

The Television White Spaces provide an excellent opportunity to demonstrate the power of new spectrum sharing technology, based on the use of geolocation and databases of spectrum availability. There are two key attractions of the television white spaces:

1. The UHF bands, where the white spaces reside, enable signals to propagate further and penetrate buildings more readily than in the higher frequency bands typically available for wireless broadband
2. Television white space spectrum is rapidly becoming a global opportunity, which opens the door to the major economies of scale seen with the other successful wireless technologies such as Wi-Fi and Bluetooth.

The fragmentation of UHF usage, of which TVWS is an integral component, may look daunting, but the technical challenges it poses create the opportunity to try new technology which can potentially harvest the untapped capacity more efficiently than traditional licence-based approaches have been able to.

3.2 Aims and objectives

The Cambridge White Spaces Trial was designed to help Ofcom translate its proposals for licence-exempt access to white space spectrum into a secure enabling framework which protects the licensed services as well as enabling innovation. It was also intended to help illustrate the potential for white spaces to service a number of key applications.

- To assist Ofcom's development of the enabling framework, the trial included a number of in-depth test and measurement projects, focussing on the protection requirements for the existing services.
- To help industry understand the application potential of television white space spectrum, the feasibility and practicality of using TVWS spectrum was investigated and the trial implemented sample applications in a number of key categories of use.

3.3 Introduction to the supporting partners

In June 2011, eleven leading companies and organisations from the communications and media sector, ranging from large multi-nationals to Cambridge-based high-tech start-ups, came together in Cambridge for the purpose of conducting this trial. By April 2012, the end of the trial, this number had reached seventeen. The consortium members are now: Adaptrum, Alcatel-Lucent, Arqiva, BBC, BSkyB, BT, Cambridge Consultants, CRFS, CSR, Digital TV Group (DTG), Microsoft, Neul, Nokia, Samsung, Spectrum Bridge, TTP and Virgin Media.

The members, together, brought a diversity of perspectives and a powerful array of experience and resources:

- Companies experienced with the operating requirements of the existing television broadcast services in the UHF band (Arqiva, BBC, BSkyB, and Virgin Media). Their expertise is being applied to help the consortium understand the maximum capacity available, consistent with ensuring that the new applications do not harm existing services;
- Companies bringing extensive knowledge of new applications, such as broadband access (Alcatel-Lucent, BSkyB, BT, Cambridge Consultants, Microsoft, Nokia, Samsung, TTP and Virgin Media);
- Global device makers (Nokia and Samsung);
- A world-leading silicon device supplier (CSR);
- Two start-ups developing TV white spaces radio technology (Adaptrum and Neul);
- A leading developer of spectrum monitoring technology and solutions (CRFS);
- An industry body responsible for shaping the specifications of digital television receivers to meet current and future requirements (DTG);
- Two geolocation database service providers, whose services are key to dynamic and flexible exploitation of the fragmented and variable spare capacity presented by the TV white spaces (Microsoft Research and Spectrum Bridge).

3.4 The Cambridge test bed network

3.4.1 Overview

The test bed network in the trial consisted of eight base stations, deployed across urban and rural locations:

- Five were in urban/city locations;
- Base stations were also installed at three member company premises (Cambridge Consultants, Microsoft and TTP), which are on the outskirts of the city;
- The mix of locations allowed evaluation of coverage and performance in different environments, as well as providing scope for a range of applications.

Unlike a conventional network, which is typically designed to yield effective coverage throughout a target area, the Cambridge Trial sites were driven by availability and likely future demand. There was no requirement in the trial objectives to establish contiguous coverage and the deployment might be more representative of license exempt deployment – for example, for hot spots or where end-users provide coverage for their own locations at their own choice/expense.

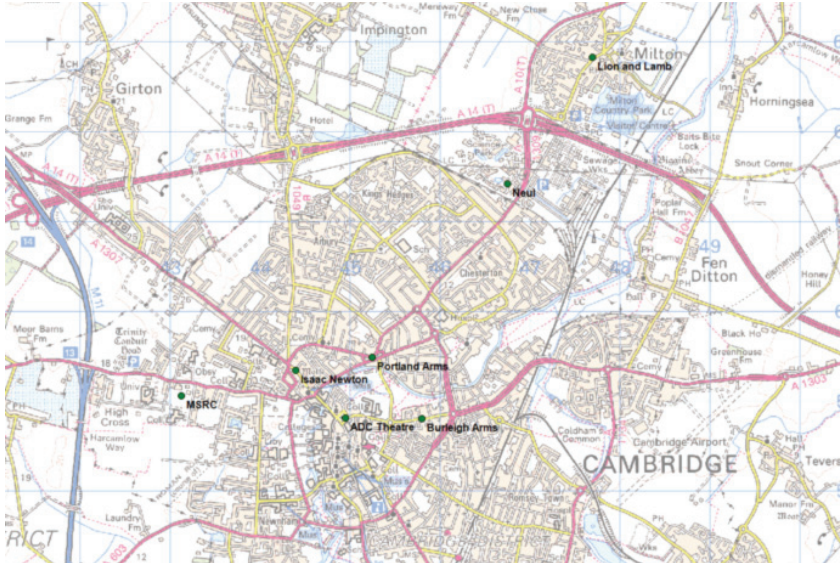

Figure 02: Trial base stations were distributed across the city. Seven of the eight are shown here.

The test and measurement programme included prediction of the coverage that would be achieved with the network's base stations, validated by measurements around the base station sites.

3.4.2 Base station commissioning process

A non-operational licence was obtained from Ofcom by Arqiva and held on behalf of the consortium, covering 19 sites around the city of Cambridge. Not all of these were ultimately used, but the diversity of allowed sites provided useful flexibility as the consortium implemented its target applications.

The licence enabled the base stations to operate up to a power limit of 4 W, using an antenna mounted at a height of 10 metres from the ground – typically on the chimney breast. Each base station could operate in any one of the ten UHF channels which were available for the trial (8 MHz each), distributed across the upper part of the UHF band: 45, 46, 50, 51, 53, 56, 58, 59, 61 & 62.

The licence was conditional on a thorough site commissioning process which had been agreed in advance with Ofcom. This entailed a visual inspection of each white spaces base-station site followed by measurements to ensure that there was no interference risk to DTT reception in adjacent residential properties.

Arqiva made the required measurements using a vehicle-mounted pump-up mast, which raised the measurement antenna to the same height as that of the base station (10 m).

3.4.3 City base stations

The city base station sites, consisting of 4 public houses and a theatre, were procured and equipped with facilities by Sky.

A flexible approach was designed for roll-out across each of these locations. It consisted of the following:

- A roof-mounted antenna (approximately 10 m from the ground in each case);
- A metal cabinet for housing the white spaces radio and supporting equipment, allowing for easy exchange of the radios as needed during the trial;
- A DSL broadband connection;
- An RF feeder to connect the TVWS radio to the roof-mounted antenna.

Each of the city base stations required a connection to the Internet, for backhaul, independently of any existing broadband provision at these premises. This backhaul connection enabled:

- Access to the geolocation database;
- Remote monitoring and control of the TVWS base station radios– under the terms of the Trial’s test licence;
- Provision of broadband internet access to invited end users – through client white spaces radios, attached to the base station in question.

3.4.4 Rural/Semi-rural base stations at member company sites

Four base station sites were provided at consortium member premises (Cambridge Consultants, Microsoft, Neul and TTP), to enable rural broadband and other innovative applications to be explored. The design and provisioning of these sites was left to the members concerned, whilst constrained by the applicable test licence and the commissioning procedure agreed with Ofcom.

Since the member company sites were light industrial/research parks on the outskirts of Cambridge, it was convenient to use two of these to provide links to rural locations. The two links established were from:

- Cambridge Consultants’ building, in the Science Park to the village of Cottenham, in the North and
- From TTP’s offices in Melbourn, to the village of Orwell, in the South.

3.4.5 TV white spaces radios used

The trial benefitted from access to equipment from leading vendors of TV white spaces technology:

- 6Harmonics
- Adaptrum
- KTS
- Neul

In each case, the technology was proprietary and first generation. TV white spaces have only been opened relatively recently (in the US) and so industry is still feeling its way in terms of standards, product requirements and implementation.

The maximum city centre base station output power achieved was of the order of 125 milliwatts (21 dBm) EIRP¹⁰ with the portable/mobile terminals having similar output power levels. The base station radios were connected by feeder cable to dual omnidirectional antennas mounted at roof-top level. The EIRP of a base station was reduced by feeder loss (up to 8 dB) whereas the same radios when used as mobile clients (for example in the PMSE coexistence tests) were able to deliver an EIRP of just over 26 dBm. Dual-antennas, with independent feeder cables, simplified changeover between radio types and also offered a latent, although ultimately untested, opportunity to counter strong interference sources such as distant powerful TV transmitters.



Figures 03 & 04: TVWS antennas, installed at the ADC theatre and at one of the pubs
Photo: CSR

¹⁰The aim was for a higher output power of the order 1 W EIRP but due to long cabling runs in the installations and power restrictions in first generation radios it did not prove possible to achieve this. Future deployments will have the capability for higher levels of radiated power.

4 Achieving the trial's objectives – overview of the test and measurement programme

4.1 Introduction

The trial aimed to show how the use of white spaces could enable a range of new applications, including rural broadband and machine to machine communications, whilst not disrupting the existing services in the UHF bands.

- Much of the test and measurement activity was focused on determining the technical requirements to achieve as effective a sharing arrangement as possible, given the need to protect DTT and PMSE services.
- The programme also included an evaluation of the coverage and performance that could be achieved using the trial's white spaces base stations – given conservative assumptions on the sharing parameters.

4.2 The Art of Interference Protection

The ultimate requirement from the sharing framework is that the services which are sharing a band do not cause disruption to each other.

The established services, namely DTT and PMSE are licensed to use the spectrum and their operators are entitled to expect that their services will not be disrupted by new applications – such as are proposed for the white space.

In current proposals, white spaces applications would be exempt from licensing and would not enjoy any protection against interference. In other words they must learn to live with interference and find a way to avoid harmful effects from it.

All users of the band will give rise to radio frequency emissions beyond their intended geographic and spectral scope – this is the nature of radio transmission, propagation and reception. The key is to ensure that such 'overspill' remains below a critical threshold within the intended coverage area of the service which is to be protected.

4.3 Ofcom's proposals for protection of licensed services

At the heart of Ofcom's plans for TVWS co-existence with incumbent services will be a database that holds DTT and PMSE frequency allocations, data on the incumbent receiver selectivity characteristics and a model for the coupling loss between a WSD and victim incumbent receivers encompassing reference geometries and propagation models. Each fixed TVWS device will be able to report its location, its device class and, potentially, other information to the database which will return a spectrum and power allocation.

The work carried out during the trial feeds in to various aspects of the database model for co-existence and to the regulatory activities that will form the corresponding policy.

For a Digital Television Network and a White Space network to co-exist in the same geographical area using interleaved 8 MHz channels in the UHF TV bands the maximum transmit power of the White Space Devices (WSD) and White Space Base Station (WSBS) must be calculated for a given impact to DTT reception.

In order to calculate the maximum permissible transmit power that a WSD could use (provided to the device via a geolocation database) there are three components that must be considered.

These components are:

- Protection ratio – The protection ratio is the minimum power ratio that needs to be maintained between the received power level of the wanted signal (e.g. a television signal or wireless microphone signal) and that of the white space device signal(s) – (measured at the DTT or PMSE receiver). If this ratio is maintained, the licensed service will not suffer any harmful impairment¹¹. The ratio is a function of the robustness of the service to be protected, including the design of the receiver and the technical characteristics of the white space device emissions (e.g. single/multiple carrier, time division duplex period etc.).
- Statistical factors – a means of scaling the effects on individual DTT receivers where the interfering WSD signal and wanted DTT signal vary significantly over a sample area or pixel, to arrive at an estimate of the impact from the WSD when part of an operational network. The current method considers the impact as a reduction in the percentage of locations receiving a DTT service in a pixel¹².
- Coupling factors – The coupling factor is a function of the separation of the WSD transmitter and DTT receiver antennas, their orientation, relative heights, gain and intervening terrain and clutter. The relative polarisation of the antennas may also be taken into account. This combination is defined by a “reference geometry”.

The protection requirements for PMSE are different to those of DTT, being based on practical considerations around existing use cases for both individual pieces of equipment and multi-channel systems employing local frequency assignments.

4.4 How the trial addressed Ofcom’s needs

4.4.1 Protection ratios and coupling factors

The required protection ratio for DTT and PMSE equipment was evaluated on the bench by the BBC. The results can be found in SE 43(12)38 and SE 43(11)92 on the ECO web site. It is hoped that the DTG, which maintains a large and representative sample of the DTT receiver models in use in the UK, will facilitate further tests.

A summary of the work carried out under the trial can be found at 6.2.

Further work on the protection requirements for PMSE equipment was carried out by CSR. A summary of the work can be found at 6.4.

Arqiva carried out field testing on reference geometries that had previously been submitted to the CEPT SE 43 working group and which were under consideration by Ofcom for its TVWS regulations.

Two particular geometries were of interest in the trial:

- Where a rooftop TV antenna is as close as 20 m from a white spaces base station antenna at a similar height
- Where a TV antenna is on a rooftop/chimney (10 m from the ground) and a white space device (and its antenna) is at street level (taken as 1.5 to 2 m from the ground).

Please refer to 6.1 for further information.

4.4.2 Statistical approaches to refining DTT protection

The strength at which a television signal is received from a transmitter depends on many factors. Predictions of signal levels take account of the terrain features such as hills and surface features such as buildings and vegetation. However, the detail does not extend to individual buildings or trees which means the signal received at a particular TV can vary significantly from the predicted value. This means TV signal levels are treated as a statistic and median values are predicted for 100m square areas or pixels. Hence a statistical model is used to estimate the fraction or percentage of households that will receive a DTT service. This model

¹¹ An additional margin for fading and other interference may also be applied.

¹² Presently SE 43 and other working groups are considering using a reduction in percentage locations (widely accepted as the model which determines the quality of the DTT signal for a required location) as the basis to calculate the maximum permissible power of the WSD. A detailed explanation of the relationship between the reference geometry and the proposed use of a reduction in percentage locations can be found in Annex A of the technical appendix of this working document.

can be extended to take into account interference from WSDs and so estimate the reduction in the percentage of locations served and so quantify the impact of WSDs on the TV network.

No testing was carried out on the effectiveness of these statistical factors, but further theoretical consideration can be found at 6.3.

4.5 The suitability of TVWS for new services and applications

4.5.1 Evaluating White Spaces Base station coverage

Arqiva commissioned the trial's WS base stations according to an intensive process agreed with Ofcom, which included checks on emission levels around the site of each base station antenna. Arqiva also used their considerable experience in predicting and measuring coverage to plan and conduct drive tests measuring signal strengths at given locations around the site of a base station, which were then compared with theoretical predictions prepared using Arqiva's propagation modelling tools. The results of the drive tests can be found at 5.1.

4.5.2 Evaluating the white spaces around Cambridge

CRFS used a monitoring network of six fixed and mobile stations distributed around Cambridge, to create a UHF spectrum usage database. The findings are reported at 5.2.

4.5.3 Estimator for white space availability

The BBC, as part of its contribution to the trial, produced a demonstrator that illustrates TV White Space (TVWS) availability calculations for the whole of the UK based on postcode entry and UKPM data. Further details on this may be found at 5.3.

4.5.4 Evaluating coverage and performance of a white space base station

The BBC, Arqiva and Adaptrum teamed up to test the coverage and performance metrics of Adaptrum TVWS equipment using one of the trial's base station sites. A report on these tests and measurements can be found at 5.4.

4.5.5 A rural broadband application

TTP installed and tested a link just outside Cambridge, using TVWS equipment to test the feasibility of using TVWS technology as a solution for rural broadband. It installed a base station at its Melbourn offices, with a directional antenna on the roof pointed towards the village of Orwell – at a distance of around 6 km. A matching white spaces radio (client premises equipment (CPE)) was mounted at a residential property in Orwell. A summary of this work can be found at 5.5.

4.5.6 An urban broadband application

Adaptrum and Microsoft installed and tested a temporary TVWS link across a solidly built Cambridge College, which illustrated the ability to deliver temporary or permanent broadband in circumstances which would have been impossible to serve using currently available wireless LAN technologies in the 2.4 GHz band or higher.

5 Results – characteristics of TVWS signals and spectrum

5.1 Cambridge TVWS signal distribution patterns

5.1.1 Description

Future base-station designs for White Space networks may use non-dominant installations; this is where the antenna is installed at a height of typically 10 m and mounted on commercial or even residential properties, depending upon the application and local end-user (CPE) requirements. In this configuration, the antennas are not above the local clutter [1]. The Arqiva technical paper titled “Coverage from White Space Base Stations” investigates the achievable coverage from such a site in the UHF TV band.

In order to measure typical propagation characteristics, 4 public houses were used as the base-station sites [2]. Test CW and wide-band DVB signals were used, together with a calibrated test receiver, using an antenna mounted on a vehicle at 1.5 m above ground level (agl.). The test signal was measured and logged, together with the position derived from GPS as the receiver moved away from the base-station location. In addition to recording the test signals, the out-of-area DTT signals were also measured [3].

5.1.2 Findings

The Arqiva paper, referred to earlier, describes an investigation of the correlation between the recorded data and common propagation models, and confirms that the results are in broad agreement with the Hata suburban model¹³. The recorded DTT measurements are compared (with appropriate height and antenna polarisation correction factors) to the UK Planning Model (UKPM)[4]. It establishes that the predicted out of area DTT signal levels from UKPM agree with the recorded data. The post-processed data is then used to predict the reduction in coverage of the WS cell.

The paper further concludes that due to the rooftop position of the base-station antenna installation, the TVWS coverage can be significantly impacted by out of area DTT, on the uplink. The downlink was impacted by intervening clutter (buildings etc.) – a factor that would tend to be reduced by increasing the base station antenna height. In some cases the coverage for portable 1.5 m reception can be limited to ranges of a few hundred meters from the base-station site [5].

Notes referred to in this section

1. In general, existing cellular base-station or broadcast transmitter installations are optimised in terms of providing maximum coverage and / or capacity and will be installed so that the site antennas are positioned above local clutter.
2. Base-station locations were part of the existing portfolio of sites for the Cambridge WS trial.
3. Cambridge is served by the local high power UHF DTT transmitter at Sandy Heath. This uses six 8 MHz channels in the UHF band. However long distance propagation from other DTT transmitters may raise the interference levels in white space channels – impacting the distance that can be achieved with a white spaces link, at a given transmission power level.

¹³At the WSD EIRP available during the trial.

4. The UK Planning Model (UKPM) is the established planning model used by Arqiva, BBC and the UK regulator, Ofcom, to predict the received signal levels of wanted and unwanted DTT signals in the UK, using a standard receiving antenna height of 10 m.
5. Later studies for an antenna height of 10 m reception confirm greater coverage areas.

[For further information, please refer to <http://www.arqiva.com/corporate/documentation/whitepapers/>, or contact Phil Kesby – phil.kesby@arqiva.com]

5.2 General spectrum survey over time of all UHF activity

5.2.1 Description of survey platform

CRFS has used a network of its RFeye® spectrum monitoring nodes, together with its Data Analysis System software tools, to survey and analyse the TV white space in and around Cambridge.

A distributed network of fixed and mobile nodes was used to create a database of the spectrum usage of the UHF bands of interest used in this trial. The nodes and usage database support real time access in order to provide current data on white spaces usage¹⁴. This data can be used to evaluate the white space spectrum in terms of a number of key performance indicators (KPIs). These KPIs are based on band occupancy, “interference” events, local variations, polarisation stability and noise floor. Updates are logged to the database over secure connections and a variety of reports has been produced.

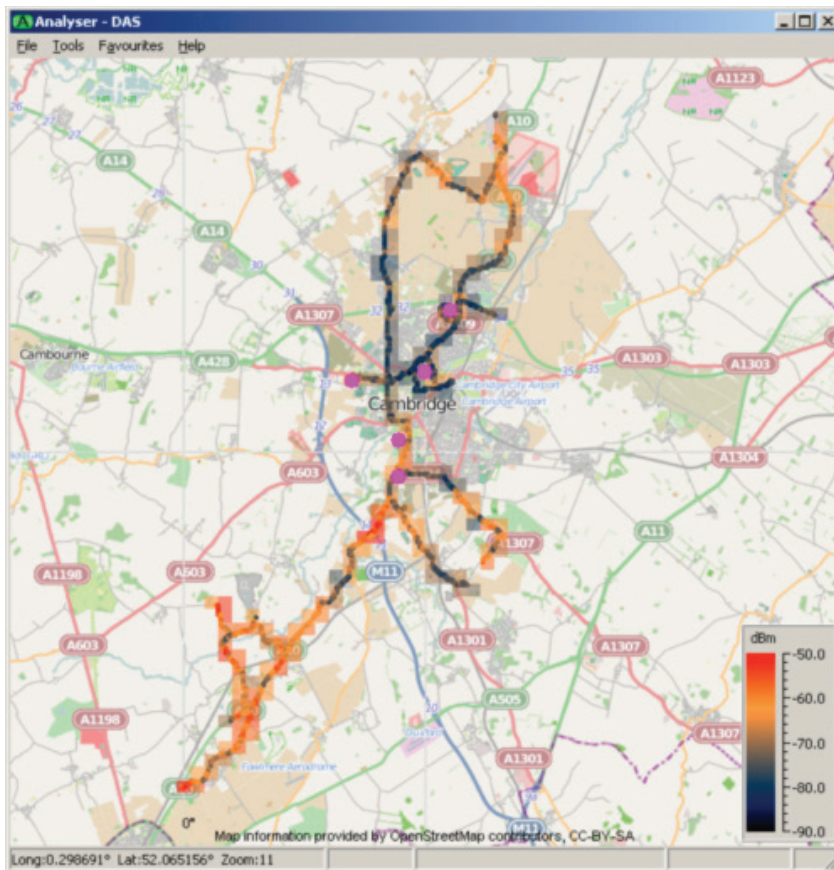

Figure 05: Locations of CRFS fixed monitoring nodes (pink markers), and combined route of mobile surveys (coloured tracks, showing peak power in 470 – 862 MHz band).

¹⁴ Information and KPIs can be obtained from each node directly, by querying a public IP address, made up from the post code e.g. cb259tl.rfeye.com

5.2.2 Survey results

The survey consisted of three elements: fixed site monitoring, mobile monitoring, and a demonstration of transmitter location.

Fixed site monitoring was carried out at five sites in the Cambridge area. The monitoring extended over several months from August to November 2011. A large amount of data was collected: spectrum scans were captured every few seconds, at a frequency resolution of 20 kHz, forming around 25 GB of data. The DAS software analysis tools were used to extract conclusions from these data: a long term trend plot is shown below:

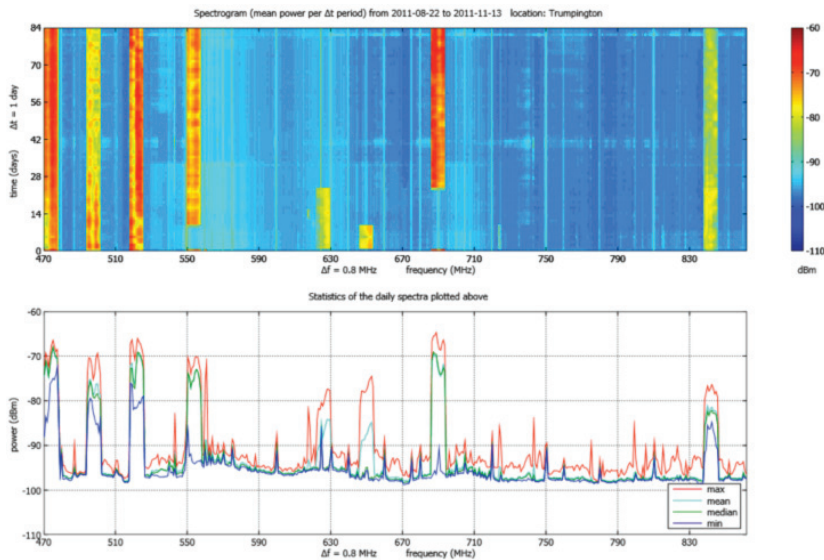

Figure 06: Long term plots compiled from the monitoring data

This shows that spectrum use is reasonably stable over a time scale of months, with some digital switchover-related activity being apparent. The spectrum between the digital multiplexes is substantially clear, with most of the detected narrowband signals accounted for by analogue TV transmissions, which were in the process of being phased out at the time of the trial. A small number of low level narrow band signals were detected that have yet to be identified.

Mobile monitoring allowed the detection of localised signals that were close to the monitored route. A number of trial white space transmissions were detected in this way. Other spectrum use confirmed the fixed site conclusions, as shown in the following example spectrum scan.

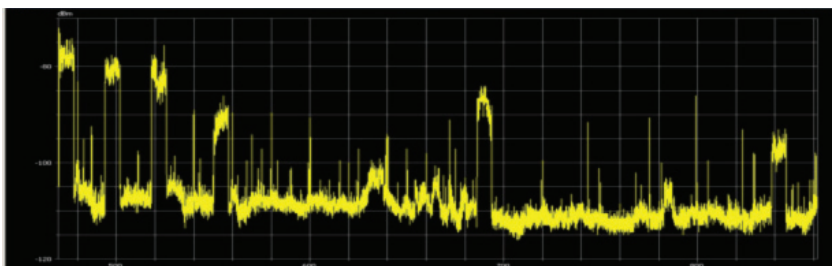

Figure 07: An example spectrum scan taken using a mobile monitoring node

The conclusions of this monitoring work are that:

1. The UHF white space channels, at the time of monitoring, were mostly clear of harmful interference, although a small number of potential narrowband interferers were detected. Digital and analogue TV signals were detected, including low power signals from distant transmitters.
2. The data produced by the network of fixed and mobile monitoring nodes provides an extremely useful, evolving picture of the “RF terrain”, and is seen as an essential complement to the geolocation databases that are used to control spectrum access for TV White Space Device communications.
3. The wideband (10 MHz to 18 GHz and above) capabilities of the CRFS monitoring nodes provide an opportunity for exploring and evaluating other potential “white space” bands.

[For further information, please refer to the reference section for report availability, or contact Dan Timson – dtimson@crfs.com]

5.3 Estimating the TV white spaces capacity in Cambridge based on postcode entry and UKPM data

The BBC, as part of its contribution to the trial, constructed a full geolocation database of the UK to illustrate the potential white space opportunity after completion of DSO. The precise algorithms used were based on a snapshot of Ofcom’s proposals and methods developed by CEPT in SE 43. Technical details of the BBC’s database construction can be found in SE 43(12)18.

Statistical analysis of the geolocation database reveals how much spectrum will be available for TVWS applications. Full details are published in SE 43(11)93. The spectrum availability, expressed in MHz, is a function of device power. More spectrum is available for low power devices than for high power devices.

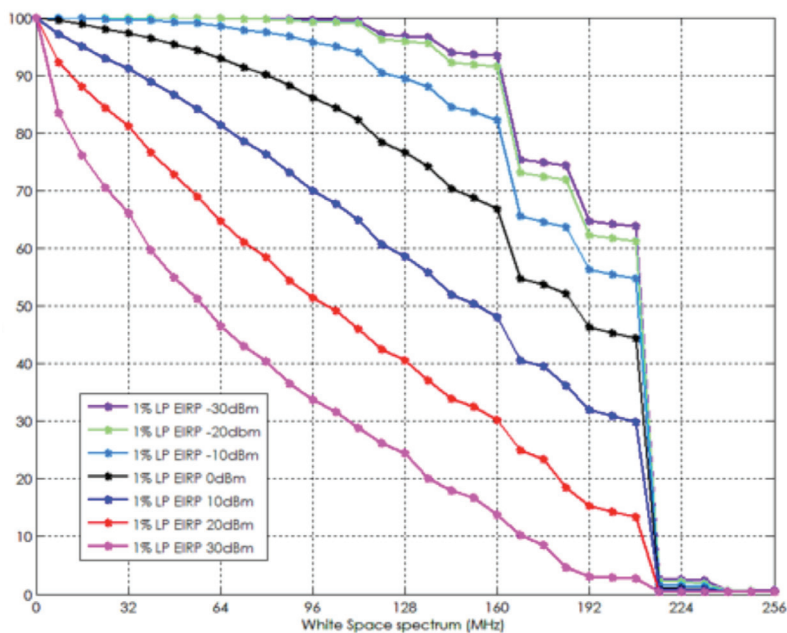

Figure 08: UK White space availability per household as a function of WSD EIRP

The spectrum availability also varies with location. The maps below show the number of channels available at different locations for two different WSD power levels.

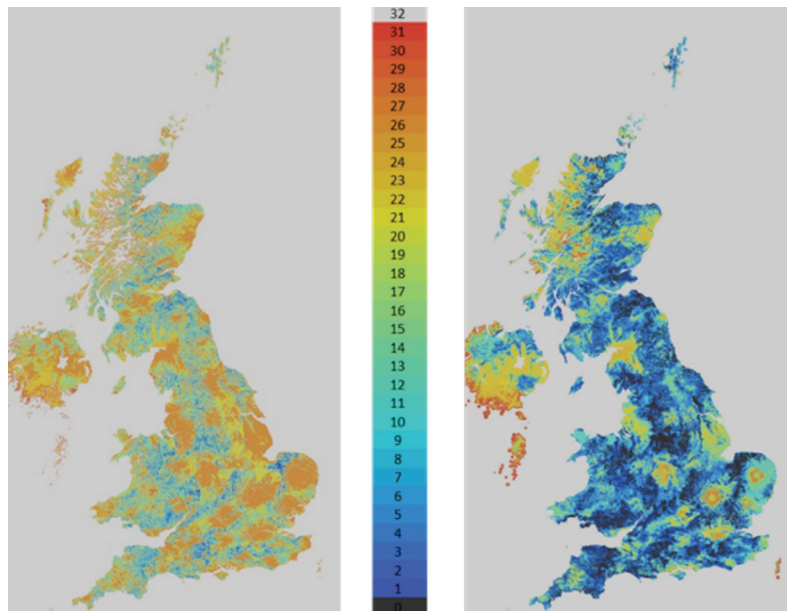

Figure 09: Comparison of TVWS availability for 0 dBm and 30 dBm EIRP

5.3.1 TVWS spectrum estimator based on postcode entry and UKPM data

The TVWS channel availability resulting from the construction of a geolocation database was demonstrated in December 2011 using a postcode checker, implemented as a web application. By using postcodes, the database could be indexed in real time to reveal the precise number of TVWS channels and power limits at any chosen location.

The post code checker provides a list of available channels and power limits for White Space Devices (WSD) based on the protection of Digital Terrestrial TV (DTT) services. The calculation is based on the detailed coverage predictions made for the UK. The country is split into 100 m by 100 m squares, called pixels, and coverage predictions are made for each pixel. The methodology used is based on Ofcom's "Implementing Geolocation" consultation document¹⁵.

For a given DTT multiplex, coverage is expressed in terms of location probability, which defines the percentage of locations within a given pixel that are predicted to be able to receive that DTT multiplex. In general, WSD signals will always have the potential to cause some interference, effectively reducing the location probability. The following assumptions were made in constructing the geolocation database:

- A degradation in location probability of 1 % has been permitted for a WSD operating 20 m from a rooftop antenna;
- DTT reception using indoor antennas, including loft-mounted and portable set-top antennas, was not assumed to be protected;
- No allowance was made for PMSE assignments;
- No margin was added for multiple WSDs operating in a pixel;
- Receiver saturation has not been modelled and low level receiver protection ratios from the Ofcom 2010 consultation document have been used. WSD signals at greater frequency offsets from DTT will cause less interference. The WSD power has been capped at 30 dBm, corresponding to a WSD interference level of -20 dBm at the DTT receiver;
- DTT protection has been limited to a subset of the Digital Preferred Service Area (DPSA) layers. Typically only 1 or 2 transmitters would be protected in a given pixel.

¹⁵ Ofcom consultation document "Implementing Geolocation", November 2010 can be found at <http://stakeholders.ofcom.org.uk/consultations/geolocation/>

Provisional algorithms were used to calculate permissible WSD power levels, which remain under development as Ofcom’s proposals evolve.

It should be noted that the WSD emission mask is linked to the protection ratio required for DTT. A relaxation of the mask would reduce permitted power levels for white space devices (or reduce spectrum availability, for applications where WSD power levels need to be maintained).

[For further information, please refer to the reference section for report availability, or contact Mark Waddell – mark.waddell@bbc.co.uk]

5.4 TVWS link performance survey

5.4.1 Description and background

The trial base stations (BS) have been deployed mostly at a number of public houses. The site at the Lion & Lamb PH in Milton which was selected for the field survey. The suburban environment and road network in the immediate vicinity of this BS made the site particularly attractive and convenient for the work.

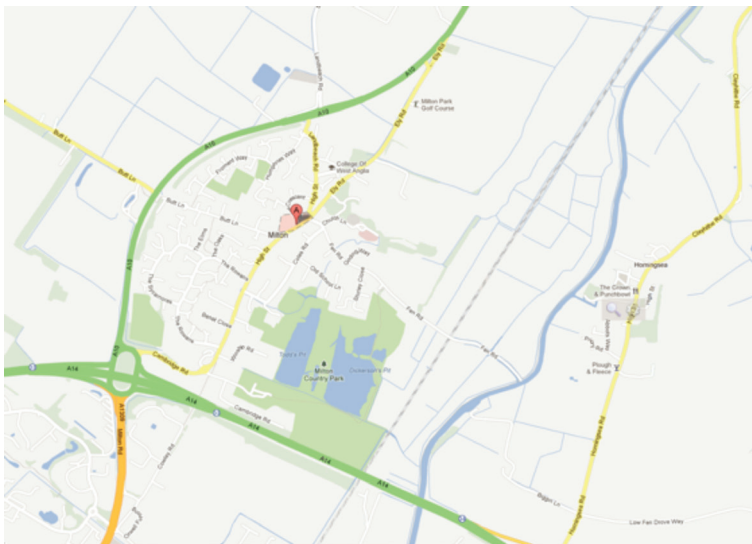

Figure 10: Map showing location of the BS in Milton at the Lion & Lamb PH



Figure 11: Lion and Lamb BS Test Site showing the omni-directional antennas
Photo: Phil Kesby

For the field measurements, an experimental TVWS radio from Adaptrum was installed at the site, and a series of mobile and fixed measurements were made using a pair of BBC survey vehicles. One vehicle was equipped with a 1.5 m omnidirectional antenna for mobile measurements and the second vehicle had a pump-up mast with a log periodic antenna for fixed measurements. The EIRP from the site, like all the sites, was rather lower than originally anticipated partly due to a high feeder loss of 6 dB loss from the base station radio to the antenna. The choice of antenna also limited EIRP, as it had little gain in its vertical radiation pattern (VRP). This, combined with the low output power of the prototype radios limited the EIRP to 0.125 W, some 15 dB lower than the 4 W figure envisaged in the license application.



*Figure 12: BBC R&D survey vehicle with elevated mast at 10 m
Photo: Mark Waddell*

The objective of the field survey was to measure the usable TCP-IP throughput for both uplink and downlink connections over a range of test points. The work explored the performance of the adaptive modulation and the RF sensitivity of the Adaptrum radio transceivers. The measurements were made at a number of test points at 10 m and 1.5 m height, in order to simulate fixed customer premises equipment (CPE) and mobile user equipment (UE) applications. TVWS spectrum is of variable quality and the measurements were repeated on CH 59 and CH 61 to explore how the coverage might vary as a function of DTT interference present from distant parts of the TV network. The test and development licences were chosen to avoid interference to TV services from Sandy Heath transmitter, but interfering signals from Tacolneston, Sudbury and Waltham are known to spill over into Cambridge at a significant level. The work was carried out over 4 days commencing the 5th March 2012 in collaboration with Arqiva, Adaptrum and BBC Distribution.

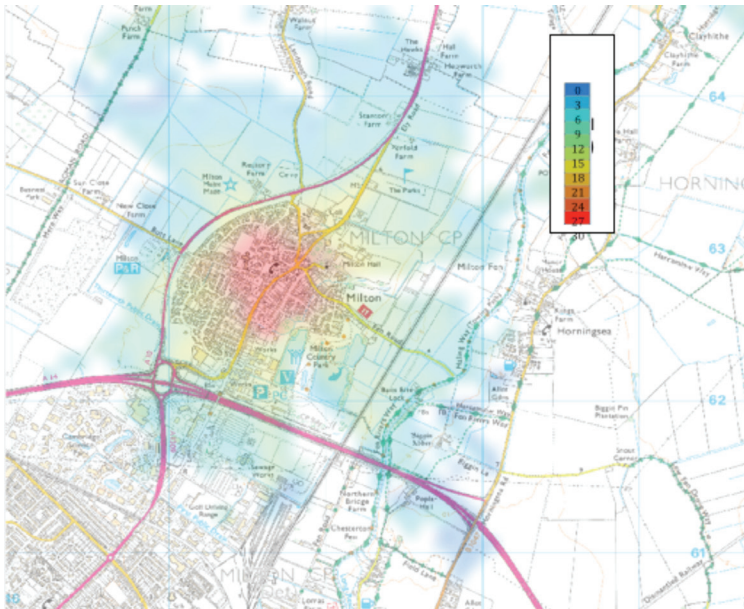

Figure 13: UKPM Coverage Prediction for CH 59 BS Coverage

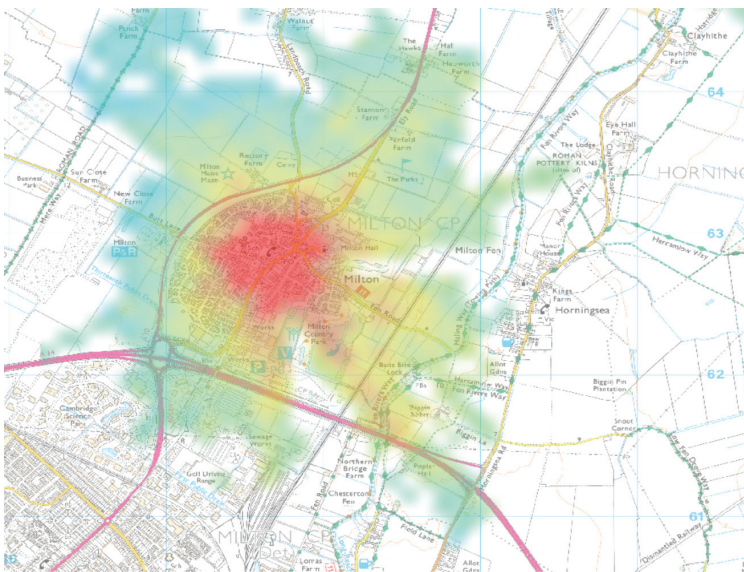

Figure 14: UKPM Coverage Prediction for CH 61 BS Coverage

5.4.2 Results

The results showed that the 125 mW base station achieved a coverage of up to 1.5 km for fixed reception at 10 m and around 400 m for mobile reception at the coverage edge. Throughput on the uplink or downlink is a function of the TDD ratio of the system. Adding the uplink and downlink throughput figures together, revealed a total useful TCP-IP bandwidth of between 13 Mb/s and 2 Mb/s dependent upon the received RF signal level at the test point. Points close to the BS enjoy high bandwidth connections whilst remote points must operate in more robust modulation modes which deliver less throughput.

The coverage predictions made using the UK planning model (UKPM) showed good agreement with the CPE measurements. The Hata suburban model, which is appropriate for mobile coverage, showed good correlation with the 1.5 m measurements and drive test logs.

The results also highlighted significant differences in spectrum quality for the two TVWS channels used. For channel 59, where there is significant interference from Tacolneston transmitter, the noise floor of the receiver is degraded by up to 11 dB, even taking account of the cross-polar operation. For co-polar operation, the

receiver noise floor would have been elevated by some 27 dB above thermal. The tests at channel 61 revealed better results, as the interference from Waltham is 6 dB lower than that from Tacolneston. The difference in interference levels is reflected in the achieved throughput, which is typically halved in channel 59 compared to channel 61.

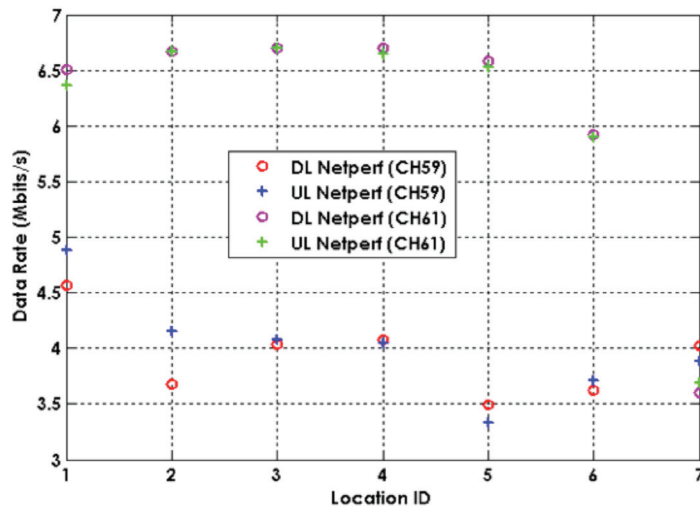

Figure 15: Throughput comparison between Channel 59 and Channel 61

The full test report, “Performance of an Experimental TV White Space Base Station for Mobile and Fixed Broadband Applications” will be published at <http://www.bbc.co.uk/rd/publications/whitepapers.shtml>.

[For further information, please refer to the reference section for report availability, or contact Mark Waddell – mark.waddell@bbc.co.uk or Darrin Mylet – darrin@adaptrum.com].

5.5 Rural Broadband link measurements, findings and analysis

5.5.1 Background

The provision of wireless broadband internet to unconnected or poorly connected rural areas is foreseen to be one of the key applications that will use TV White Space spectrum. In the UK alone, at least 10 % of premises have no access to broadband or less than 2 Mbps. The technical limits of wired ADSL and the high cost of installing optical fibre in remote locations makes it imperative to find a cost effective wireless solution so that everyone can have good access to the internet.

TV White Space spectrum is characterised by large amounts of geographically available spectrum with excellent propagation characteristics, ideal for providing fixed broadband internet services to locations where the routing of cables or optical fibre is neither practical nor economic.

5.5.2 Trial Description

TTP established a trial white space link from its premises in Melbourn Science Park, Hertfordshire, to a residential property in Orwell, a distance of 5.6 km across the fields of Cambridgeshire. Prototype radios provided by Neul were used, which offer a raw PHY data rate up to 16 Mbps using 16 QAM with convolutional coding.

The base station and antenna were installed on the roof of the TTP DaVinci building on the Melbourn Science Park, with the antenna at a height of approximately 12 metres above ground and an EIRP of +36 dBm using a directional antenna.

The Consumer Premises Equipment (CPE) consists of a Neul terminal and associated directional antenna, mounted at ~7 metres in the loft of the domestic premises, with an EIRP of +31 dBm.

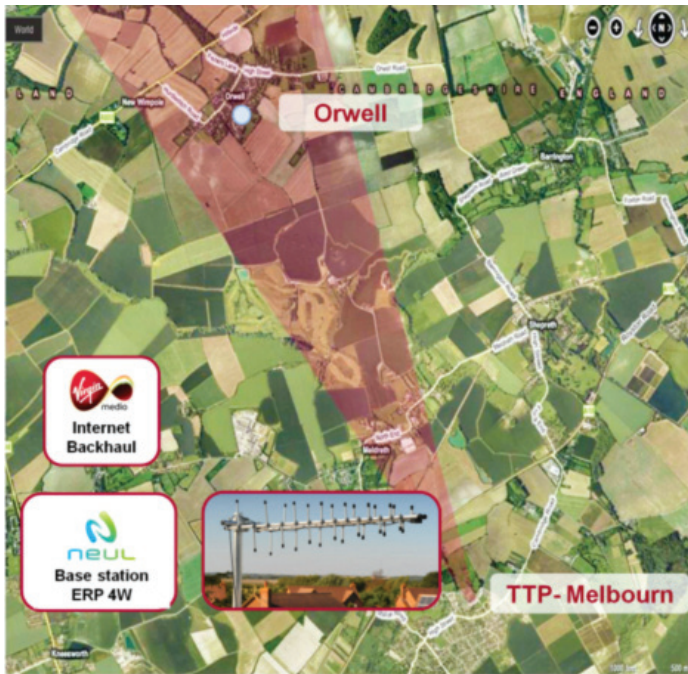

Figure 16: The TTP Base station providing broadband service to Orwell

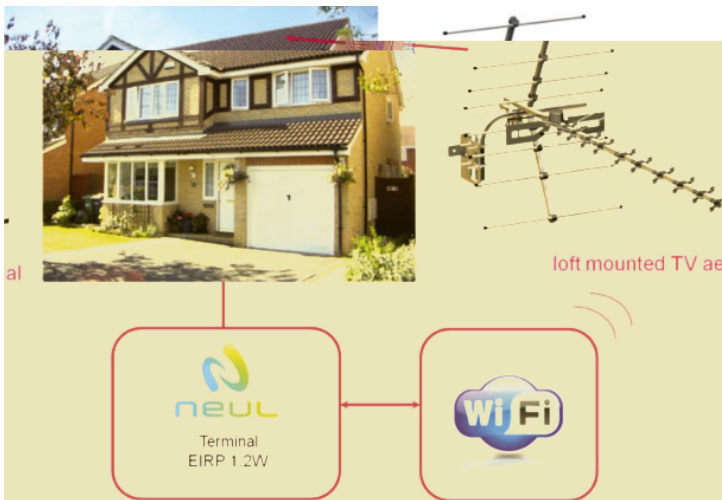

Figure 17: The residential property in Orwell, where a White Space to Wi-Fi bridge was installed

5.5.3 Findings

TTP's work in the Cambridge TV White Space trial has very clearly demonstrated the benefit and the feasibility of serving rural communities using White Space technology.

An internet service speed of up to ~8 Mbps downlink, with a corresponding ~1.5 Mbps uplink was established to the domestic premises in Orwell (using approximately 80/20 downlink vs uplink time division on a single TVWS channel).

5.5.4 Analysis and Conclusions

Further theoretical analysis was undertaken by TTP (which can be found in a separate report) to evaluate the potential performance of TVWS broadband provision.

TTP's conclusions may be summarised as follows

- 140 dB path loss capability is the minimum requirement for the radio system performance.
- Resultant service coverage versus speed depends on acceptable limits. TTP have assumed a 10 Mbps trunk link for 5 Km coverage as 'acceptable'

- For 140 dB path loss capability and a 10 Mbps 'service' trunk link:
 - CPE EIRP needs to be at least 2 Watts
 - CPE must be mast mounted on the roof of the property, as high as possible.
 - Professional installations of CPEs are likely to be required
 - Base station EIRP needs to be approximately 40 Watts
 - Base station location must be carefully selected and the antenna mounted as high as possible
- In band interference coming from distant transmitters will affect network planning figures
- Time Division Duplexing (TDD) is preferred to keep down costs and complexity of radio design
- The Digital Inclusion Objective is hard to meet without using broadband wireless services
 - Better to get the un-served locations connected with email and basic web browsing capability, than having nothing at all.
- Although fibre roll-out is the superior choice for super-fast broadband, White Space offers a solution where fibre installations are neither practical nor economic.

The following table and figure estimate the performance achievable using a single channel TDD white space link. BTS EIRP 40 W (10 – 12 metres height) and CPE EIRP 2 W (rooftop mounted).

Path Loss (dB)	Cell Edge at 90 % Coverage Probability ITU R P 1546 (Km)	Net Trunk Downlink Service (Mbps)	Net Trunk Uplink Service (Mbps)
120	2	23.32	11.23
125	2.6	20.08	9.08
130	3.2	16.85	6.96
135	4	13.63	4.89
140	5.2	10.43	3.01
145	6.5	7.34	1.53
150	8.3	4.52	0.63
155	10.3	2.3	0.22

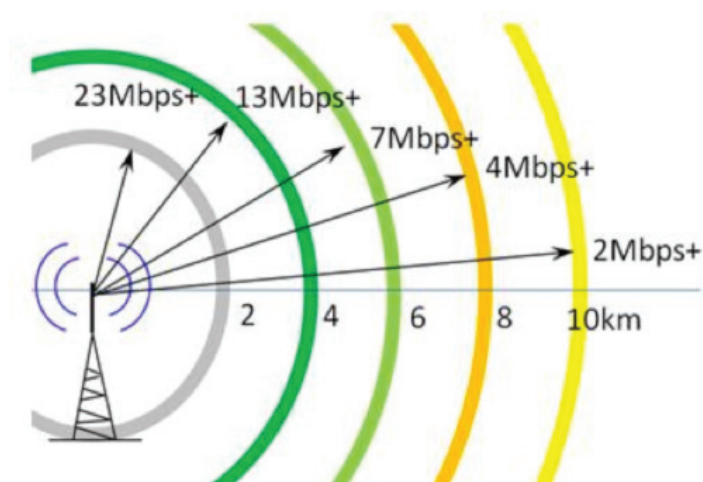

Figure 18: Analysis based on Shannon +3 dB margin and 65 % PHY>MAC> Network packet efficiency with 60/40 downlink vs uplink timings

[For further information contact Andrew Fell – Andrew.fell@ttp.com]

6 Results – reviewing Ofcom’s proposed protection requirements for DTT

6.1 Field measurements of DTT path losses /coupling factors

6.1.1 Aims and description

This piece of work is concerned with the coupling factors. Two scenarios (reference geometries) are considered:

1. A WSD consumer unit (aka customer premises equipment) with an antenna at 1.5 m above ground level (agl) into a DTT receiver with an antenna at 10 m agl;
2. A WSD base-station with an antenna at 10 m agl into a DTT receiver with an antenna at 10 m agl. The scenarios are defined by the two reference geometries below.

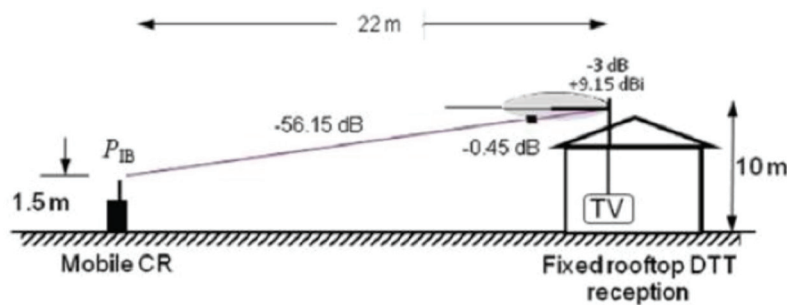

Figure 19: Reference geometry 1 for a 1.5m WSD device to a 10 m DTT antenna

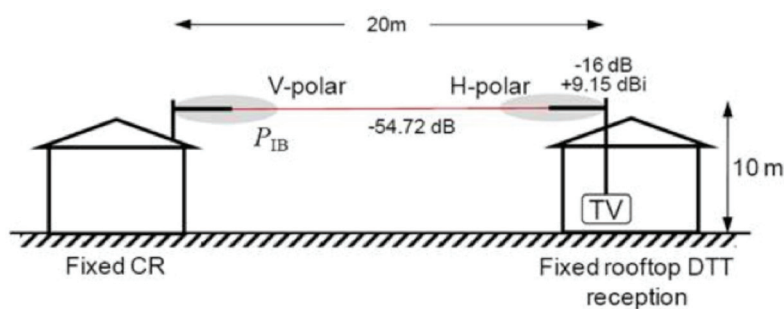

Figure 20: Reference geometry 2 for a fixed 10m WSD device to a 10 m DTT antenna

The aim of the tests is to see whether the current reference geometries are consistent with measurements and to propose any changes to the way the reference geometries are applied where appropriate. Measurements relating to reference geometry 1 (1.5 m to 10 m) were conducted in Cambridge as part of the original White Space Trial and also at Crawley Court, the Arqiva Offices in Hampshire, to provide a more detailed investigation under controlled conditions. Measurements relating to reference geometry 2 (10 m to 10 m) were only made at Crawley Court.

6.1.2 Results

The work consisted of practical tests carried out as part of the Cambridge WS trial, and correlates the findings to a 2-ray theoretical model and concluded with a proposal to modify the polarisation discrimination that is used with reference geometry 1, proposing that it should be set to zero.

The assumptions used with reference geometry 2 are in good agreement with measurements of cross-polar discrimination made as part of the tests at Crawley

Court. However, observations of how WSD base-stations have been deployed in Cambridge show that a fixed or default distance of 20 m as used in reference geometry 2 is too large. The distance should be made a variable in the geometry that can be used when the distance between the base-station and nearest DTT antenna is known, or set to a much smaller default distance when it is not known.

Further work is proposed regarding the minimum distance for reference geometry 2 and the standard deviation as used in reference geometry 1.

[For further information, please refer to the reference section for report availability, or contact Phil Kesby – phil.kesby@arqiva.com]

6.2 Bench measurements of thresholds for interference from TVWS signals with a representative selection of DTT receivers

6.2.1 Description and background

This section presents a summary of the results of DTT receiver protection ratio measurements which are required to ensure adequate DVB-T reception in the presence of interference from whitespace devices. A number of candidate technologies have been assessed and the resulting DTT receiver performance is presented.

The protection ratio values have been obtained from laboratory testing of 14 commercially available DVB-T receivers in the presence of a wanted DTT signal from a test generator. The receivers chosen are current designs being marketed in the UK and include IDTVs, STBs and PVRs. The interfering whitespace signal in each case has been implemented using a vector signal generator to replay a waveform previously recorded from a candidate whitespace technology radio.

The test programme used 30 test signals taken from recordings of the uplink and downlink signals of 5 WSD candidate technologies (Wi-Fi, WiMAX, LTE, WSD1, WSD2¹⁶). An automated test system was developed by the BBC, enabling over 50,000 measurements to be made within a period of 9 months.

6.2.2 Results

The results show a considerable spread in performance. As expected the protection ratios are a function of frequency, as shown below:

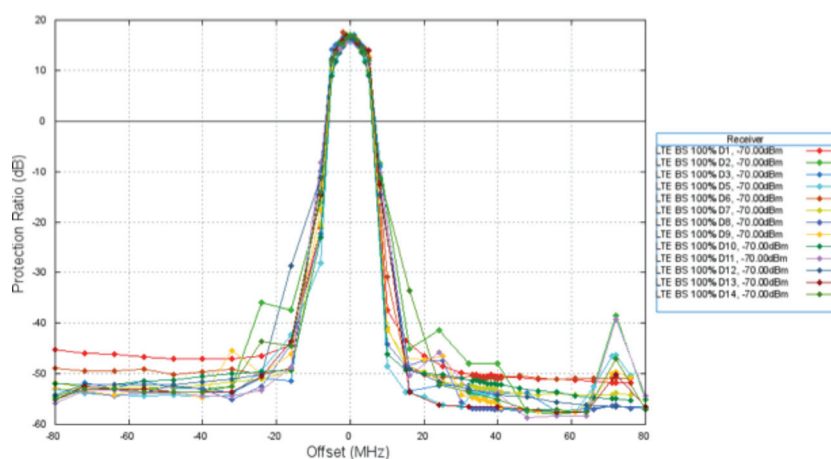

Figure 21: Protection Ratio for all Receivers LTE 100 % BS. Wanted signal -70 dBm

¹⁶WSD1 and WSD2 are radio technologies used in the Cambridge trial.

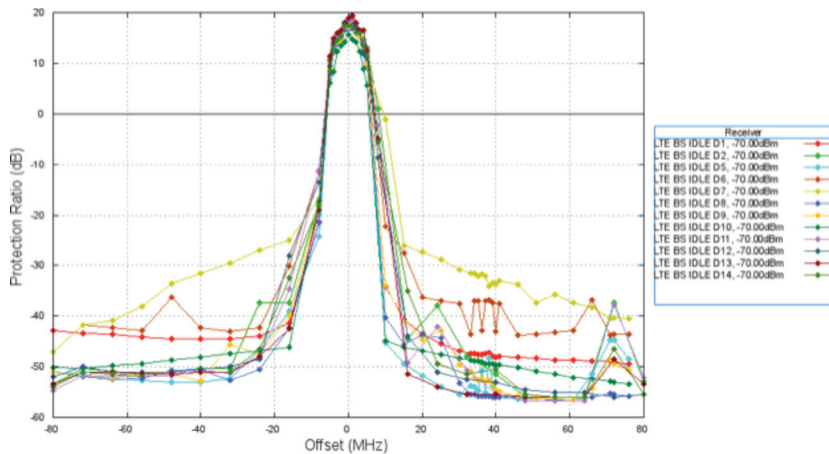

Figure 22: Protection Ratio for all Receivers LTE Idle. Wanted signal -70 dBm.

The protection ratios are also strong functions of level and WSD technology type. The WSD signal typically causes the most interference at low traffic load. The spread in performance for different signals can be quite marked, as shown below. Terminal devices (UE and CPE) tend to be very bursty in character and cause sporadic interference and pixelation to DTT reception.

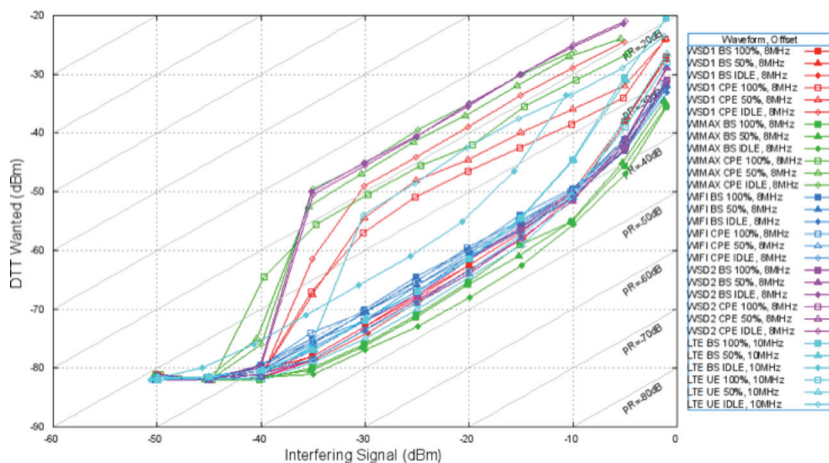

Figure 23: C/I for a poorly performing receiver 8 MHz offset

One or two high-end receivers appear fairly resilient to interference from WSD, but the remainder show vulnerabilities to particular candidate technologies. The WSD technology causing the greatest interference impact varies from receiver to receiver. Broadcast-like signals (e.g. LTE BS 100 %) are handled without difficulty, but bursty signals (e.g. low traffic CPE signals) result in up to a degradation of up to 30 dB in protection ratios on some models of receiver. Further investigation of these issues will be required if the value of the TVWS is to be fully exploited.

We conclude that WSD deployments will initially require the use of conservative protection ratio values in order to protect the installed base of DTT receivers. A geolocation database based approach to TVWS is feasible, but will be of greater value only if the database is able to take account of the WSD technology class and predicted field strength.

[For further information, please refer to the reference section for report availability, or contact Mark Waddell – mark.waddell@bbc.co.uk]

6.3 The complexity of RF propagation and application of statistical techniques

The following is a brief description of the theory behind the application of statistical techniques that can be applied to DTT reception. No tests on this theory were conducted during the trial but it is considered important to cover this topic to provide a more complete picture of reception and interference.

The maximum EIRP that a WSD may transmit will be conveyed by the geolocation database. To determine the WSD power the calculations used to populate the database need to take into account the maximum interference that the TV service can tolerate. If the location and height of the WSD antenna are known¹⁷, then the following parameters can be established, and the maximum power of the WSD can be calculated:

- Coupling loss between the WSD and the closest TV receiver;
- A protection ratio, which takes into account the WSD signal characteristics (including the standard (e.g. Weightless, IEEE 802.22 etc.) and configuration) and the susceptibilities of the TV receiver¹⁸;
- The predicted levels of the wanted and unwanted DTT signals on the channel of operation of the victim DTT service being considered.

However, in general the exact location of TV receiver systems relative to WSDs will not be known. There will be uncertainty over the following factors:

1. The separation between WSD and TV receiver system;
2. The effect of any local clutter and building attenuation;
3. The TV receiver antenna pointing and in some cases the WSD antenna pointing;
4. The antenna discrimination for WSD and TV combination;
5. The performance of the TV and WSD combination for given frequency separation;
6. The level of the wanted TV signal.

These uncertainties lead to a requirement to apply statistical techniques in estimating the impact of WSDs on TV reception. There are a number of possible approaches to applying statistics. Two of these may be summarised as follows:

- Absolute worst case: The WSD EIRP would be limited so that even for the geometry resulting in lowest coupling loss with the worst performing TV receiver there is no loss of TV service.
- Accept that there will be a loss of service at some viewing locations, and hence possibly to some viewers, under some circumstances, but this is limited to a prescribed amount.

The absolute worst case leads to very low EIRPs, of probably no more than a few milliwatts, and would drastically limit the utility of WS and prohibit many applications. This leaves the second option, but this approach can have many variations which can lead to very different permitted maximum WSD EIRPs.

In planning the DTT network within the UK, each 100 m by 100 m area (pixel) has a predicted median field-strength using an industry agreed planning method, referred to as the UK Planning Model (UKPM). If a uniform standard deviation is assumed across all pixels in the UK there is then an implied percentage of locations served within the pixel. In assessing the effect of emissions from WSD, it has been proposed that WSDs should not reduce the percentage of locations served in a pixel by more than x %, and 1 % is the working assumption for x. Within a pixel, there may be six TV transmissions (multiplexes) available for reception and the WSD EIRP would need to be set in power so that the worst affected TV transmission had no greater than a 1 % loss of percentage locations.

¹⁷For fixed installations, additional antenna characteristics can also be provided by the WSD to the database such as angular discrimination and polarisation discrimination.

¹⁸Protection ratios will vary dependent upon the selected combination of DTT receiver and WSD standard (and configuration)

When the WSD and TV receiver system are in close proximity, this typically will be the most restrictive to the WSD EIRP and there are two possible approaches:

1. The use of fixed reference geometries, which normally correspond to the lowest coupling loss (including the worst antenna alignment and lowest polarisation discrimination). This represents a worst case, in this context;
2. The use of Monte Carlo modelling techniques to allow the variables 1 to 6 described above to vary with an appropriate distribution, variance and range. Clearly the result in this case will be sensitive to the assumptions about the distributions, but in general would imply higher maximum WS EIRPs.

The reduction in percentage locations computed by the methods described above gives a guide to the number of households that may either suffer impairment to their TV service or lose it totally. It is a measure of the impact on the TV network availability rather than viewer experience directly, though the two are clearly related. The viewer experience is further complicated by the viewers' choice of channels and time of viewing. The resulting impact of possible WS applications on viewers' experience is very difficult to compute.

In summary, it is possible to use statistical methods to estimate the impact of WSDs on TV reception rather than rely entirely on worst-case projections. Doing so can aid the construction of the database such that the EIRPs of WSDs can be allowed to operate at the highest level possible without affecting the TV service beyond pre-determined limits.

There are several practical examples of Monte Carlo simulations which aim to predict how varying the "uncertainty" factors mentioned above will affect the impact on DTT reception and the consequential TVWS operational parameters. These examples include papers by Arqiva and Neul. The latter also estimates the effect on TVWS network costs of a certain set of statistical parameters.

[For further information, contact Steve Cherry – Steve.Cherry@arqiva.com or William Webb – William.Webb@neul.com]

6.4 Assisting with Ofcom's protection requirements for PMSE

6.4.1 Description and background

This section describes work carried out in a theatre to measure coupling losses between TVWS devices and PMSE equipment and the consequent susceptibility to interference.

The amount of spectrum available for WSDs depends upon a number of factors including decisions on the level of protection afforded to the incumbent services and how well the WSD can cope with interference from these services and other WSDs.

The sections that follow consider the protection requirements for Programme Making and Special Event (PMSE services) in enabling new applications to access the white spaces. Radio microphones are the most common PMSE applications, but others include in-ear monitors, by which performers can receive instructions from directors and producers without needing to interrupt their performance.

During live performances, the PMSE equipment users have to consider carefully the choice of channels and deployment of the equipment to minimize the risk of interference¹⁹. There are uncertainties due to the human body shielding microphone transmitter signals on body-worn and hand-held systems, multipath fading in indoor cluttered stages and reverse intermodulation products generated when two or more transmitters are in close proximity causing blocking of a third.

¹⁹The risk arises currently from wireless microphone users in adjacent locations, such as pubs, or from passing news crews, for example.

Major public events such as the Olympic Games and the Eurovision Song Contest make extensive use of PMSE devices such as radio microphones (RMs) and in-ear monitors. As licensed users of the spectrum, it is important to protect these services, as it is to protect DTT services.

Spectrum sensing and other cognitive techniques have been considered by the CEPT SE 43 work and are not considered practical partly due to risk that the device carrying out the sensing is somehow shielded from the potentially vulnerable transmissions (referred to as the hidden node issue). The preferred method of PMSE protection is to use a database which the WSD accesses and based on the location of the WSD and other factors, it is advised which RF channels are free to use and the maximum power level for operation.

Policy makers (including Ofcom) are looking to understand what limitations need to be applied to WSDs when used near PMSE applications to prevent harmful interference to wireless microphone links. In this trial, CSR measured the practical margins required to prevent harmful interference and to get a sense of what margins PMSE users are working with in practice.

This work was completed in several phases:

1. Bench tests (performed by the BBC): Bench measurements carried out using recorded transmission signatures of the WSDs coupled into sample PMSE devices;
2. Further bench testing and characterisation of equipment using actual WS equipment in conducted measurements;
3. On-location tests: Measurements in a co-operating theatre (CSR used the ADC theatre in Cambridge). Wireless microphones and WSDs were set to channels available within the trial non-operational licence to allow co-channel and adjacent channel protection margins to be assessed.

6.4.2 Results

With the assistance and cooperation of several PMSE vendors, measurements have been conducted in a theatre in Cambridge to check co-existence of TVWS with analogue and digital microphones and in-ear monitors (all of which are widely used on live stage performances). The results of these tests, using up to four pre-standard Weightless White-Space devices, from Neul, simultaneously operating at 400mW EIRP and conforming to the FCC mask, have been encouraging.

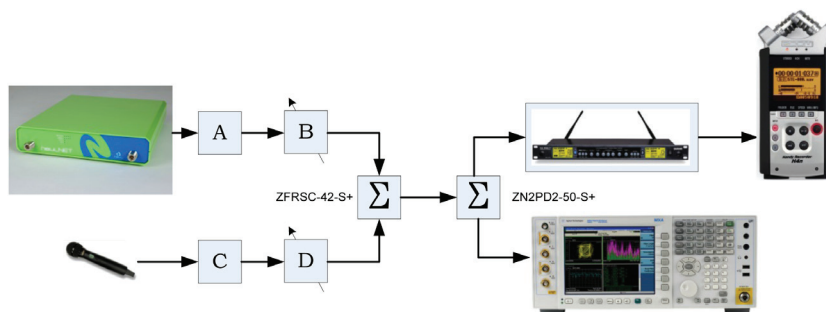

Figure 24: Radio Microphone Bench Test Configuration

Measurements have shown in the lab and at the ADC theatre in Cambridge, that for typical PMSE equipment, a co-channel protection zone would be in the order of 200 m for WSD with EIRP's of 26 dBm and it is predicted that for devices of 4 Watts, the protection zone would be 400 m radius. This is consistent with a 20 dB building attenuation and third-order propagation loss. For a different building density, or for outdoor events, the limits imposed by the FCC of 400 m for +20 dBm and 1 km for +30 dBm seem appropriate.

With White-Space systems using TDD (such as the Weightless pre-standard), it is not possible for more than one White Space device to be transmitting at the same time, thus cumulative effects can be ignored. However, further consideration to the minimum distance should be given if multiple white-space systems were deployed in the same location.

Adjacent channel protection for the PMSE Rx depends upon the WSD transmit spectral purity. With the Neul WSDs, the protection zone around the PMSE Rx of more than 5 m should be used for 1st adjacent channels and greater than 0.5 m for 2nd and subsequent adjacent channels.

A limited series of tests was conducted on two separate multi-channel PMSE systems (comprising 12 channels), as are commonly found in larger theatres and other venues requiring large numbers of radio microphones and in-ear monitors.



Figures 25 and 26: The ADC auditorium and a Neul WSD, in situ
Photos: Les Smith

As these systems use a number of carriers, the possible effects of intermodulation are considered and the power levels and frequencies are selected accordingly.

The initial findings of tests of a 12 channel PMSE system in the presence of a TVWS device indicate that very close proximity of a WSD to a radio microphone operating on an adjacent channel does have the potential to cause interference.

If there is a possibility that a WSD can be very close to a radio microphone, then operating a WSD in the adjacent channel can be avoided. In fact, the adjacent channels of a multi-channel radio microphone system usually contain intermodulation products from the radio microphones themselves which have the potential to cause interference to the WSD, thus deploying the WSD no closer than the 2nd or further adjacent channel would be prudent for both WSD and PMSE systems.

[For further information, please contact Les Smith – les.smith@csr.com]

7 Summary of findings and recommendations

7.1 Review and analysis of the key findings

7.1.1 Headlines

The headline message from the coverage and performance testing is that TVWS technology can and will work to deliver services that are attractive to consumers, beneficial to UK plc and will help to meet government objectives in reducing the digital divide.

Furthermore, through detailed bench and field work, the trial has demonstrated the successful coexistence of TVWS with the incumbent services, in a number of defined scenarios, within constraints on transmission power that arose largely from the capabilities of the available TVWS radios and installation requirements (long feeder cables were needed). However, the studies conducted within these constrained circumstances have helped to define and in some cases propose new frameworks which should ensure that TVWS applications can be deployed more generally in a broader range of scenarios and with potentially higher transmission power, where this can be achieved without impairing the incumbent services.

7.1.2 TVWS applications

Looking first at the spectrum availability and performance aspects of TVWS as tested in the Cambridge area, CRFS's survey has shown that whilst background noise and interference levels vary somewhat, there are no significant, unforeseen impediments to the use by TVWS of UHF spectrum not reserved for DTT or PMSE.

Using the BBC's postcode TVWS channel estimator and other available data, we learnt that between 15 and 21 UHF channels may be available for TVWS use at different power levels, which is enough for a very significant level and variety of services.

Arqiva's coverage measurements indicate that propagation of TVWS signals approximates to the Hata model and is therefore predictable for the conditions encountered in the trial; it is likely that broadcast network planning tools based on that used for the UKPM could be adapted to assess and plan TVWS coverage.

In terms of practical applications, TTP's rural broadband application demonstrated the non-line of sight reach and added capacity that TVWS can provide. The capability to put white space to work in the surrounding area by both incumbents and new entrants alike would allow businesses and residents access to more broadband. Adaptrum, Arqiva and BBC built on this success by showing that a practical, large "hot spot" city application could support the use of planned and/or temporary broadband popup Wi-Fi hotspots. Ultimately mobile devices with native TVWS support could be enabled in both rural and urban areas where there is usable white space.

7.1.3 Coexistence of TVWS with DTT and PMSE

Within the trial a number of bench and field tests have been carried out to investigate some of the essential elements of a co-existence regime for TVWS and incumbent services. The studies have helped to refine and in some cases propose new frameworks which Ofcom and other regulators developing TVWS regulations are encouraged to note and take into account, to ensure that TVWS can operate without causing impairment to the incumbents' services. The results are summarised in the remainder of this section.

The BBC's bench test work on DTT and PMSE products has produced a significant volume of information about the protection ratio performance of these products in the presence of a range of TVWS signals from equipment supplied by several vendors. This will be invaluable in constructing the UK's geolocation database.

Further investigation and analysis into the volumes of the different types of DTT receiver in the market would help to ensure that unrepresentatively poorly performing products are not being afforded undue protection at the expense of the value that could be created by TVWS applications and services. Additionally, it is recommended that the DTG²⁰, undertakes further investigation and work with the aim of achieving further improvements to coexistence between DTT and TVWS through updates to the DTT specification and recommendations to TVWS vendors.

Arqiva's work to validate two of the reference geometries submitted to CEPT SE 43 and under consideration by Ofcom has found that they are in general, fit for purpose as architected. These geometries are the basis for determining the coupling factors that apply between a WSD and a TV antenna with respect to different TVWS use cases. A minor amendment is recommended for reference model #1 (TVWS mobile device at 1.5 m to DTT antenna at 10 m). With regard to reference model #2, it was observed that the separation between rooftop DTT and TVWS antennas in the Cambridge Trial deployment was closer to 10 m. The application of a reduced distance to all locations with dwellings would result in severe power restrictions on TVWS base stations of this type so it is recommended that further consideration is given to the creation of an additional reference model (or models). It may also be possible to avoid such blanket restrictions implied by a change to this reference model by, for example, requiring certain rooftop installations in some areas to be carried out by professional, skilled installers, who will make the necessary checks.

The work carried out by the Consortium on a statistical approach to calculating the impact of TVWS systems on DTT networks reminds us that coupling factors and protection ratios have a spread of values which depend on the following:

- TVWS modulation scheme.
- The wanted DTT signal.
- The DTT receiver performance.
- The frequency spacing between the TVWS signal and the DTT signal.
- The physical location of TVWS device with respect to the DTT receiver system.

Using reference geometries with a minimum fixed protection ratio constrains the TVWS to low EIRPs. These constraints will only be appropriate to a relatively small proportion of locations. The question still to be investigated is what proportion of locations? A reduction in the percentage locations served in a 100 m × 100 m pixel of 1 % due to the presence of TVWS devices is under consideration.

More work is now required on how the database will allocate TVWS EIRPs based on the median value of the wanted DTT signals in the pixel plus allocating values to the list of variables above. The Consortium members wish to ensure that the impact on DTT reception, in terms of locations served in a pixel, is not reduced by more than 1 % while at the same time enabling the WS networks to use the highest EIRPs possible.

CSR's work on PMSE services both in the lab and in a local theatre under realistic conditions demonstrated a level of immunity in radio links of the professional PMSE equipment tested from TVWS signals that pleasantly surprised other trial members. It is clear that this immunity is dependent on a) the adjacency of the

²⁰ One of the trial consortium members and the body responsible for specifying and testing the UK's profile of DVB (and other) standards for DTT.

frequencies being used by the WSD and the PMSE equipment, b) the quality of the PMSE equipment, c) the sharpness of channel filtering and power level of the TVWS devices and d) the proximity of the WSD to both the PMSE receiver and transmitter. These considerations will need to be taken into account by regulators.

Further tests were conducted, with a multi-channel PMSE system, to investigate the possibility of signal artefacts (intermodulation products) being generated or exacerbated by interaction between TVWS devices operating in close proximity to a PMSE transmitter causing audible impairment on one or more channels. It was confirmed by operating a TVWS device within 0.5 m of a radio microphone that this interaction is possible. Some further work is needed to establish the minimum protection range between a WSD to a PMSE device; from the promising results so far, this is believed to be a few metres. Furthermore, it was determined that two or more WSD's coming into close proximity with each other could generate further intermodulation products, and the regulator should investigate how it can be ensured that these products will not fall in the licensed PMSE band.

7.1.4 Developments outside the trial – standards and other trials

The Cambridge White Spaces Consortium is aware of work recently instigated at ETSI to standardise the interface between white space devices and geolocation databases. Several trial consortium members who are also ETSI members pledged support to the creation and ultimate success of this work stream. Similarly, there is work under way in the IETF, under the PAWS²¹ working group, which is working towards a global standard for device/database communication. It is expected that ETSI and IETF will align basic standardisation of the device-to-database protocol.

The consortium is also aware of the interest in the trial of administrations and committees based outside the UK. The membership recommends these administrations and committees allow more than one database and service provider, authorised purely on the basis of a provider's ability to meet the technical requirements.

7.2 Recommendations arising from the technical work carried out in the Cambridge trial

- Members of the consortium have successfully demonstrated the value that TVWS can contribute to a number of key applications within the Trial, including rural broadband provision, city broadband coverage enhancement, machine to machine applications and location-based services. Administrations and regulators should recognise the economic and social value which TV white spaces and database-enabled spectrum access could facilitate, though improving efficiency of spectrum use.
- The Trial has successfully tested several of the important concepts and techniques that are required for TV white space devices to co-exist with the licensed services – namely digital television and PMSE. Given the use of a database to enable TV white space spectrum access, any changes arising from the evolution of market requirements and technology advances can easily be accommodated. Administrations should expeditiously develop and implement regulations that enable consumers to benefit from the new applications of TVWS, whilst ensuring that co-existence with incumbent services is adequately catered for.
- Administrations should take note of the adjustment to the reference geometry for DTT protection from TVWS mobile devices recommended out of Arqiva's field tests. They should also take note of Arqiva's recommendation to further consider how uncertainty in the separation between a roof top TVWS antenna and a DTT antenna can be managed such that impairment of DTT reception is avoided.

²¹Protocol for Accessing White Spaces

- Administrations should ensure that protection ratios and coupling factors used in the geolocation database are up to date and representative of equipment in the field. Each new candidate WSD technology will require a comprehensive programme of testing to evaluate the appropriate protection ratios for the database. These protection ratios will also depend on the emissions masks chosen by industry and ETSI. Tighter masks would enable an improved power/spectrum availability trade-off.
- Administrations should encourage the continuous development of WSDs, DTT and PMSE equipment to ensure that technology opportunities for increasing the efficiency of spectrum use are exploited. Industry must also play its part.
- Administrations should allow multiple TV white spaces device profiles for use by the database, including support for roof-top, mobile, and indoor fixed deployments, and require the minimum necessary power to be used. The permitted WSD emission power will be a function of the WSD technology, ACLR mask and interference characteristics established through protection ratio measurements. If administrations decide to protect indoor antenna reception as well as fixed reception, studies show that some spectrum is still likely to be available for TVWS applications but higher power WS devices would need to be kept clear of populated areas.
- Administrations should investigate and where possible, test the benefits of statistically modelling the assumptions and variables used in the geolocation database. Where appropriate, factors should be incorporated into the geolocation database to ensure that interference mitigation is proportionate and not wholly based on a combination of worst case reference geometries, coupling factors and protection ratios. A successful balance would provide sufficient protection for incumbents and at the same time, enable higher power WSD applications. Administrations should ensure that PMSE users have adequate protection from harmful interference. In particular, the geolocation database should be used to prevent co-channel frequency allocations to TVWS devices within the specific site of a PMSE allocation. Consideration of intermodulation distortion and WSD IMD performance may also be required, in determining available channels and WSD emission limits in the vicinity of PMSE venues.
- Administrations should encourage the use of PMSE conforming to professional standards²² by limiting protection to the level required by products that meet those standards.
- Guidelines should be produced for PMSE users such that interference from WSDs operating on adjacent channels can be prevented by ensuring minimum separation safeguards between WSD and PMSE transmit and receive equipment similar to those found in the trial. In the case of multi-channel PMSE systems, it seems likely that a separation of a few metres will be required between a WSD and any radio microphone that is part of that system. The trial consortium understands that further tests are being undertaken²³ to validate and elaborate on these findings as WSD technology develops.
- Spectrum monitoring can have a role to play in establishing the efficient use of spectrum by increasing the transparency of its use – both authorized and unauthorized. Real-time networks of low-cost monitoring nodes could help white space applications to optimize the selection and use of channels indicated as available by a geolocation database. Administrations should recognise the value of spectrum monitoring and consider promoting its use as part of a progressive approach to managing spectrum more efficiently.

²² Such as ETSI EN 300 422, with recommendations ETSI TR 102 546 and ETSI TR 103 058

²³ Ofcom was given full access to the tests and test data produced within the trial and is reported to be carrying out further tests at Baldock.

8.1 Glossary of acronyms

ACLR	Adjacent Channel Leakage Ratio
Agl	Above ground level
DTT	Digital Terrestrial Television
PMSE	Programme Making and Special Events
TVWS	Television white spaces (UHF)
UKPM	UK Planning model (for DTT)
WSD	White Space Device

8.2 A message of acknowledgement to the members of the test and measurement work strand

The editor of this document, Martyn Lee at Sky, would like to record his very grateful thanks and appreciation to the group of professionals who performed the test and measurement programme summarised in this document.

Specifically, I would like to thank Phil Kesby, Steve Cherry and Simon Mason at Arqiva; Haiyun Tang and Darrin Mylet at Adaptrum; Mark Waddell and Chris Nokes at the BBC; Dan Timson at CRFS; Les Smith at CSR; William Webb at Neul; and Andrew Fell at TTP for their hands-on contribution to the work. I would also like to thank Pekka Talmola at Nokia and Chris Cheeseman at BT for bringing their experience and expertise to the regular conference calls and the drafting of this document. The assistance of the PMSE vendors, via Brian Copsey is also appreciated. Finally, I would like to thank Andrew Stirling, Adriana Mattei and Amer Hassan working for Microsoft, the excellent contributions from whom have improved this and other trial documents beyond all recognition.

8.3 An overview of standards activities relating to TVWS

A number of Standards groups have been developing standards for operation in the TV white spaces. These include the following working groups:

- **IEEE 802.11 TGaf.** This is the primary group within IEEE 802.11 that defines a specification to meet the legal requirements for TVWS access for low power devices. The Standard is under development and expected to ratify Q4 2013. However, a stable draft of the Specification is possible by September 2012. The TGaf community assumes geolocation is the approach to use of TVWS channels. The PHY and MAC enhancements will refer to 802.11ac, which is the high speed (Gbit) 802.11 Standard in the 5 GHz. This is done by down clocking to TV channels bandwidth (normally 6 MHz or 8 MHz worldwide) Use of 802.11ac enables channel aggregation of non-contiguous channels. The Wi-Fi Alliance formed a Marketing Task Group to develop a Marketing Requirements Document as bases for future certification of TVWS devices
- **IEEE 802.22** Working Group developed and ratified a specification for wide area networks fixed broadband access. This is thought to be suitable for rural coverage and possibly urban applications
- **IEEE 802.15 TG4m** is a new Study Group to evaluate and develop specifications for low rate (40 kbps – 2 Mbps), long range WPAN in TVWS bands.
- **Cognea** is a consortium that developed a TVWS Standard (later ratified by ECMA-392) focused on home network applications, such as distribution of HD content and broadband access

- **Weightless** is a Standard under development by a recently launched special interest group. It's primary focus is machine-to-machine (M2M) application, providing low data rates at extended range (> 3 km), and ultralow power battery consumption (~ ten years in certain cases). The Weightless standard is expected to be complete towards the end of 2012
- **IETF PAWS** (Protocol to Access White Space database). This is an effort to develop a standard for devices to geolocation database communication. Such a standard is one of three required to launch a TVWS product: the other two being PHY/MAC and the standard for communication between geolocation databases. It is possible that a stable PAWS draft will be available by the end of 2012.

Other related standards groups include the following:

- **IEEE 802.11ah**, called the sub-1 GHz Task Group. This group will develop a Standard for use in SmartGrid and other vertical applications using the ISM bands in < 1 GHz
- **IEEE 802.18** Working Group to address regulatory issues affecting IEEE 802 technologies
- **IEEE 802.19** has the objective to develop Standards or best practices for coexistence amongst IEEE 802 technologies. An effort was launched to address coexistence of different technologies in the TVWS bands
- **SCC 41** defines layers above the MAC and PHY for dynamic spectrum access networks
- **IEEE 1900**
 - **1900.7** is the relevant group under SCC 41 and
 - **1900.6** specifying Spectrum sensing techniques.

8.4 References

- List of associated, more detailed technical reports carried out by members
<http://www.arqiva.com/corporate/documentation/whitepapers/>
<http://www.bbc.co.uk/rd/publications/whitepapers.shtml>
<http://media.crfc.com/uploads/files/1/crfc-cambridge-white-space-report-a04.pdf>
- Other useful source of information
 The CEPT SE 43 documents are located at: <http://cept.org/meeting-documents>.
 By selecting the group SE 43, all of the relevant SE 43 working group documents can be accessed and downloaded.



The Cambridge White Spaces Consortium gratefully acknowledges the expertise and support of Adaptrum, Arqiva, BBC, CRFS, CSR, DTG Testing Ltd, Microsoft, Neul, BSkyB, TTP and wireless microphone suppliers in conducting these tests.

The Cambridge White Spaces Consortium comprises the following companies:

