



Microsoft Research

Faculty
Summit

2014 15TH ANNUAL

Remixing and post-human design

Jeffrey V. Nickerson

Collaborators: Yue Han, Harris Kyriakou, Pinar Ozturk.
This material is based upon work supported by the
National Science Foundation under grants 0968561 and 1211084.

Post-human design







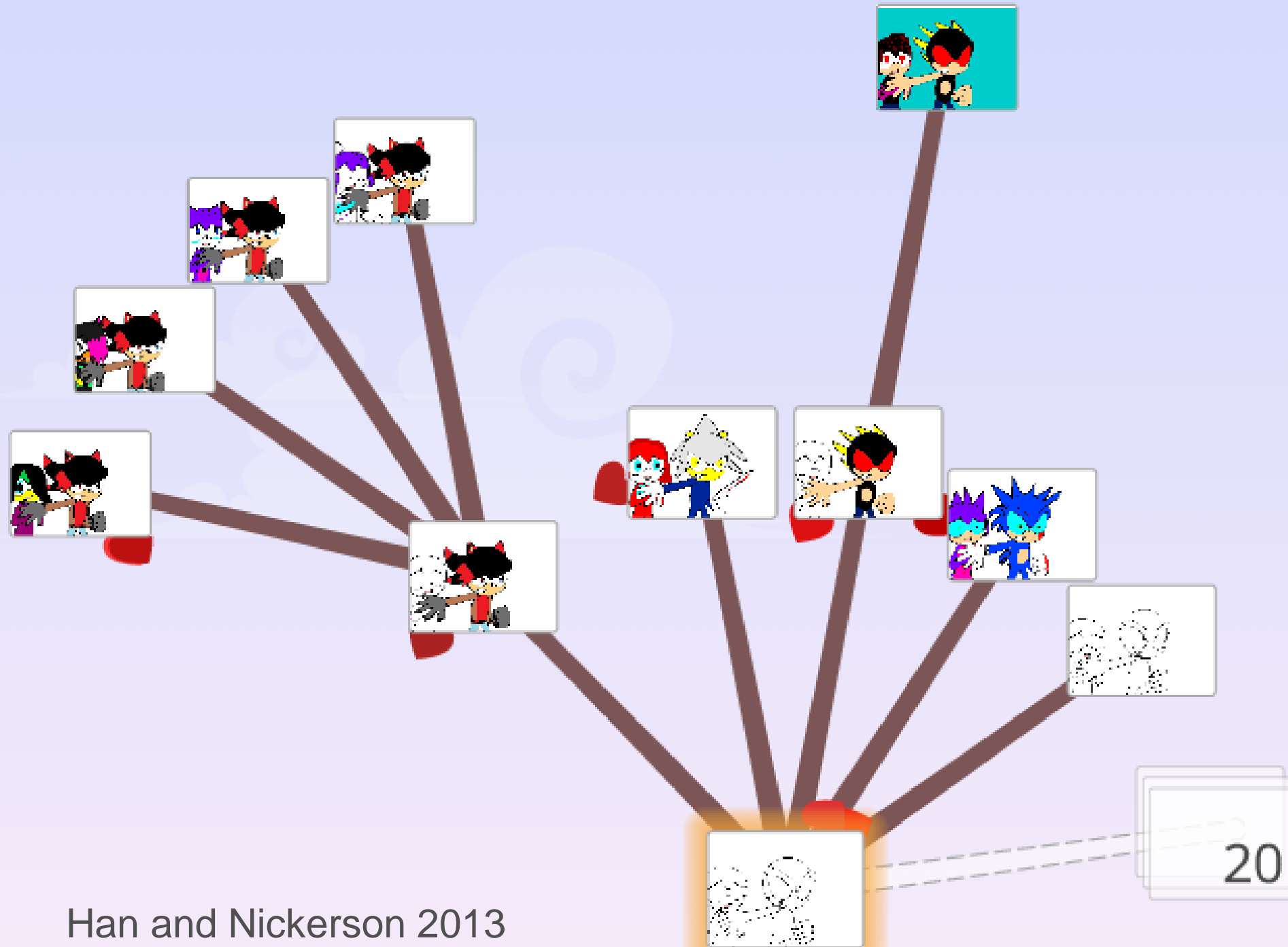

Han and Nickerson 2013

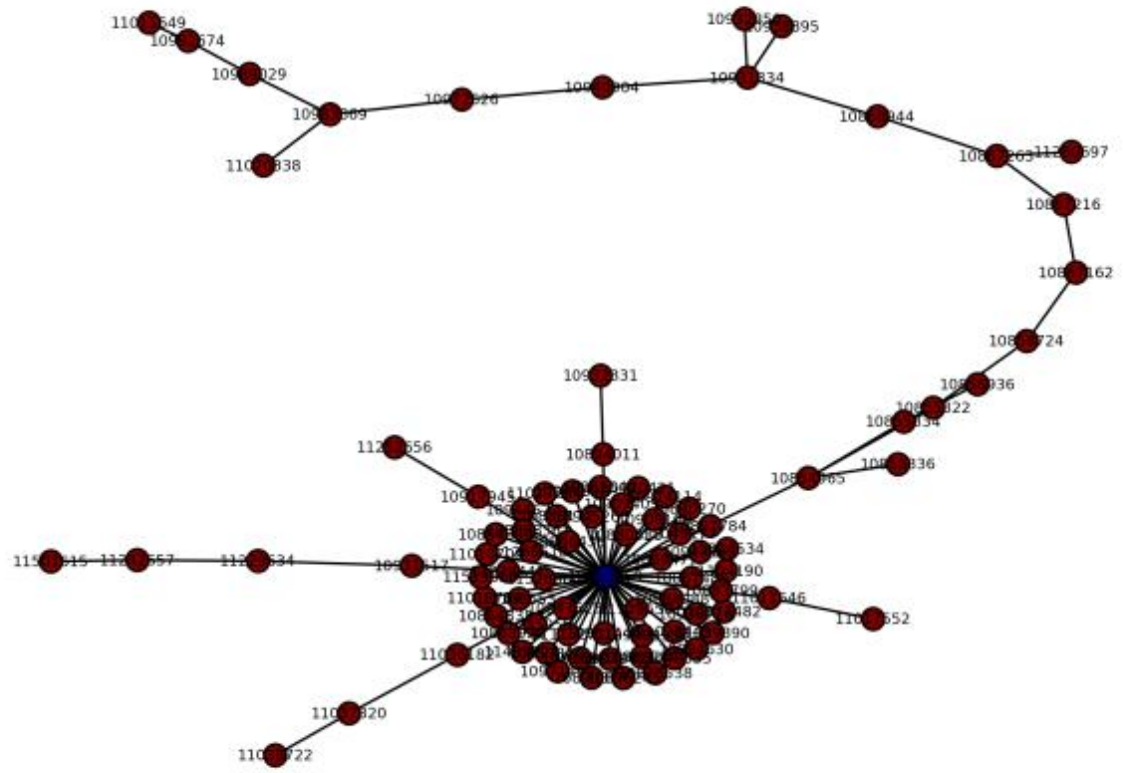

Han and Nickerson 2013

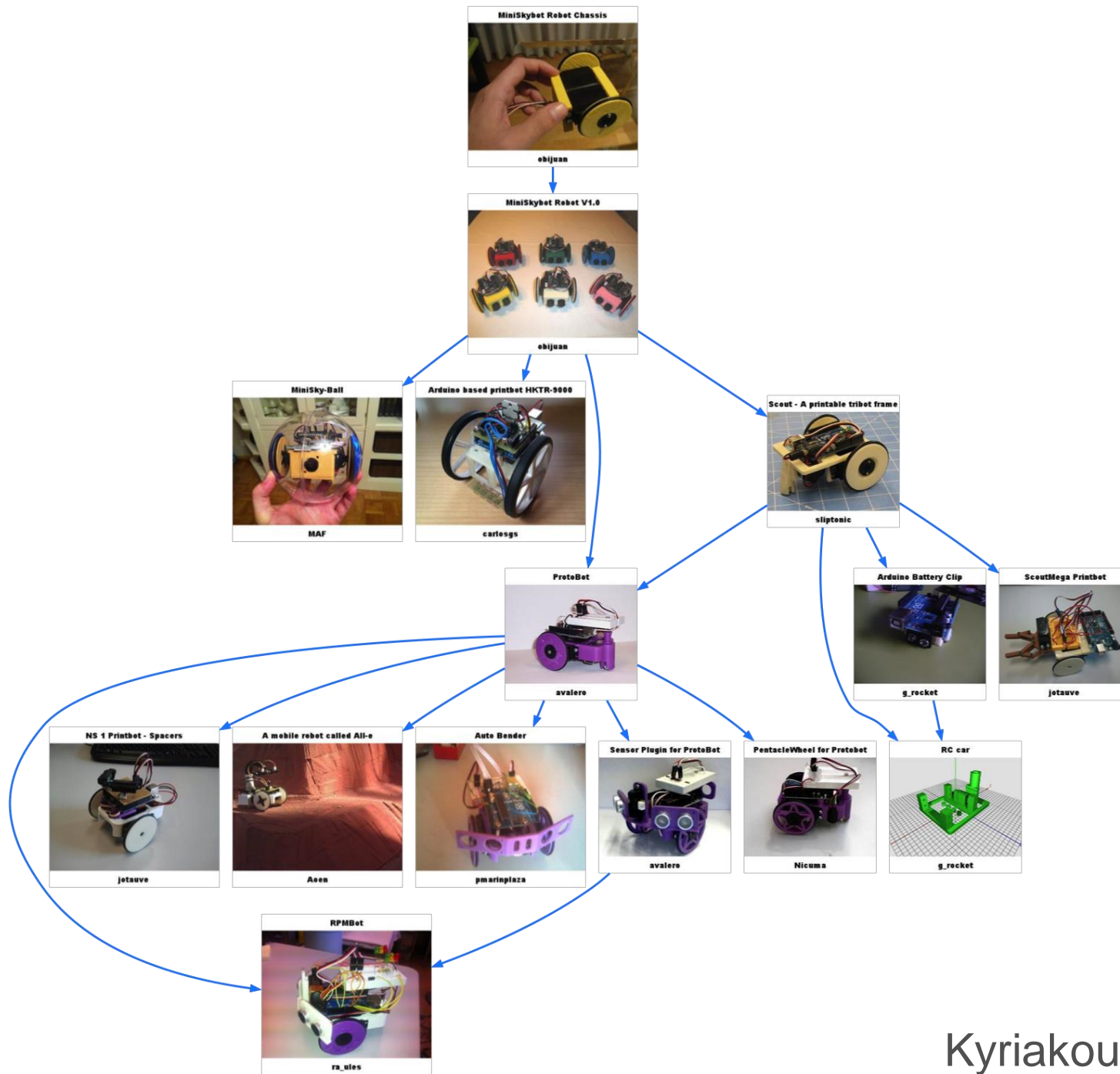

Remixing

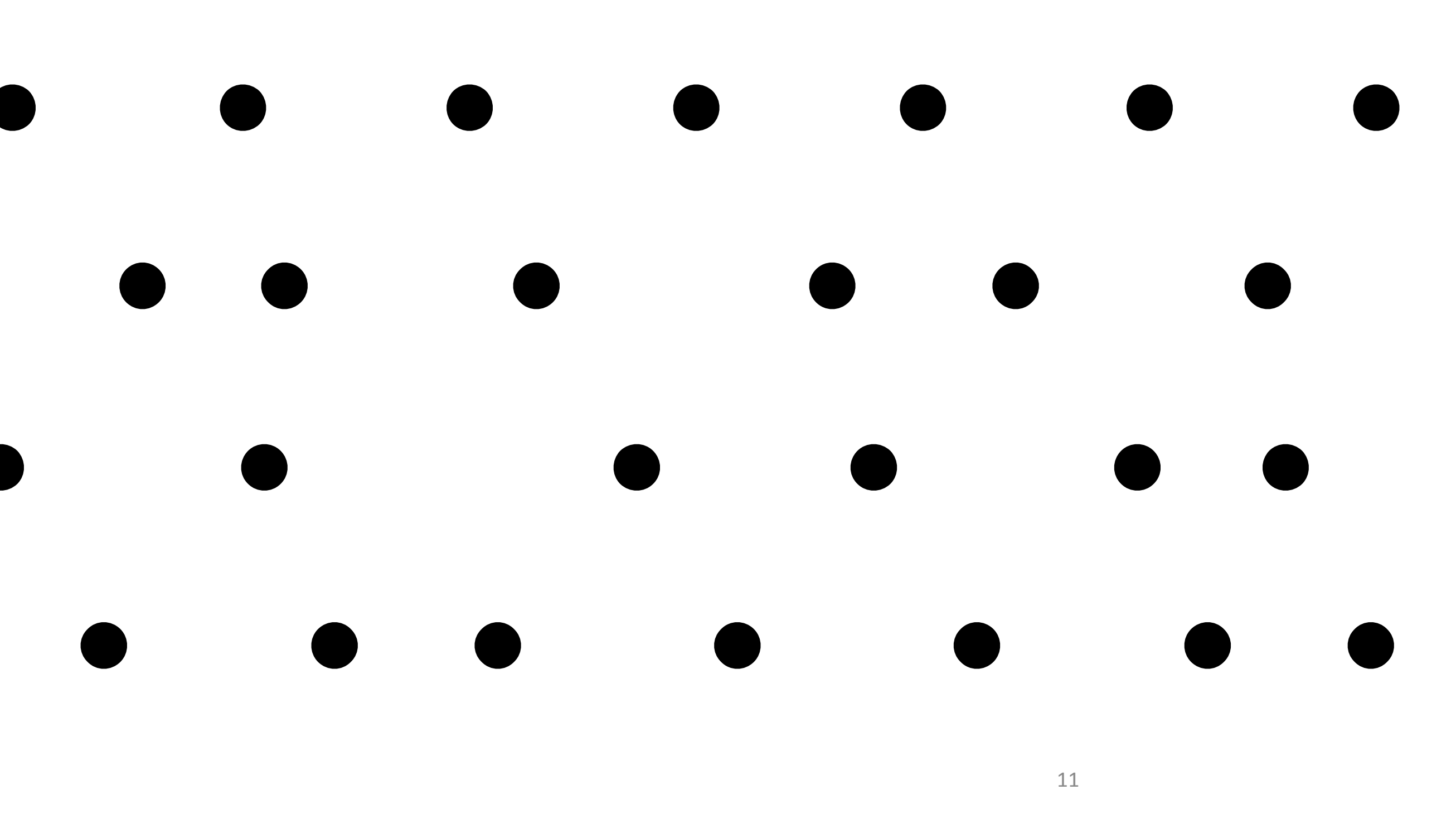

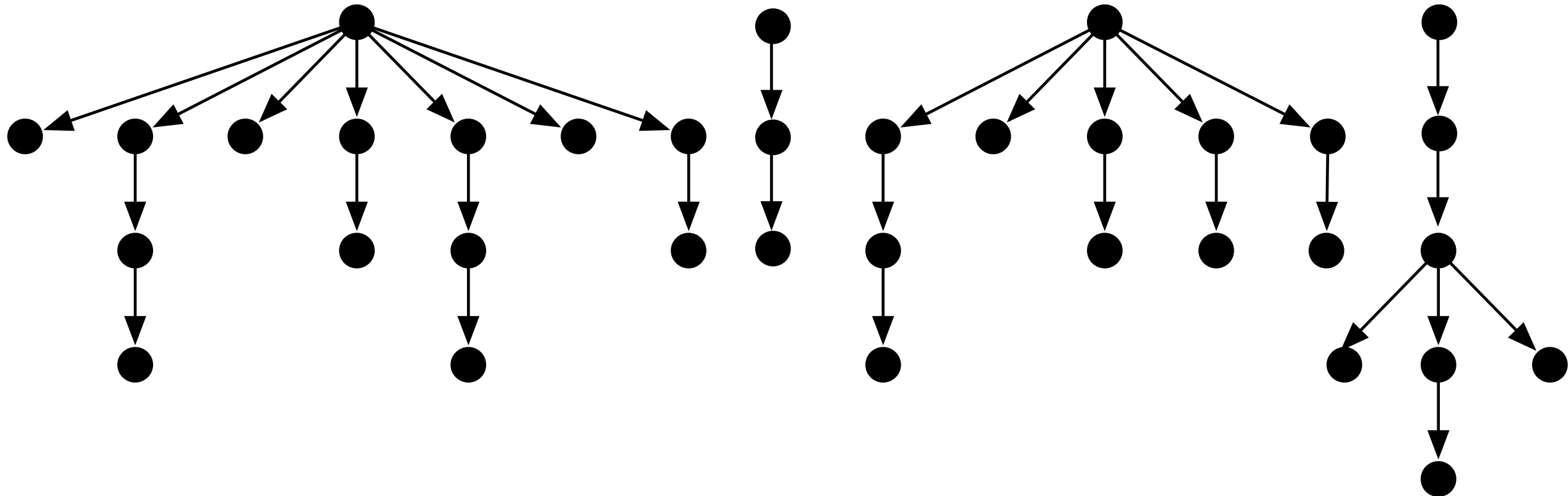

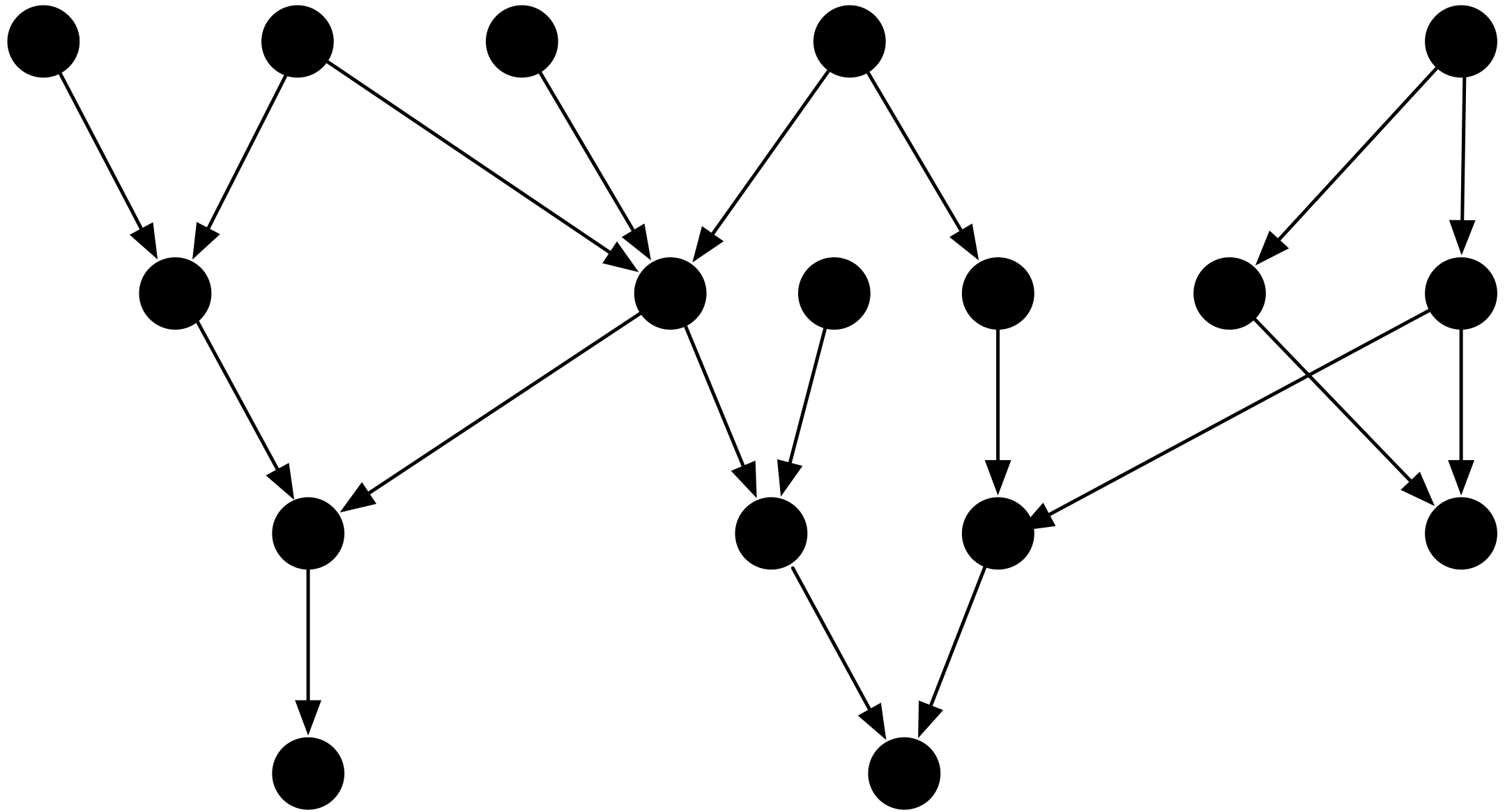

Visibility

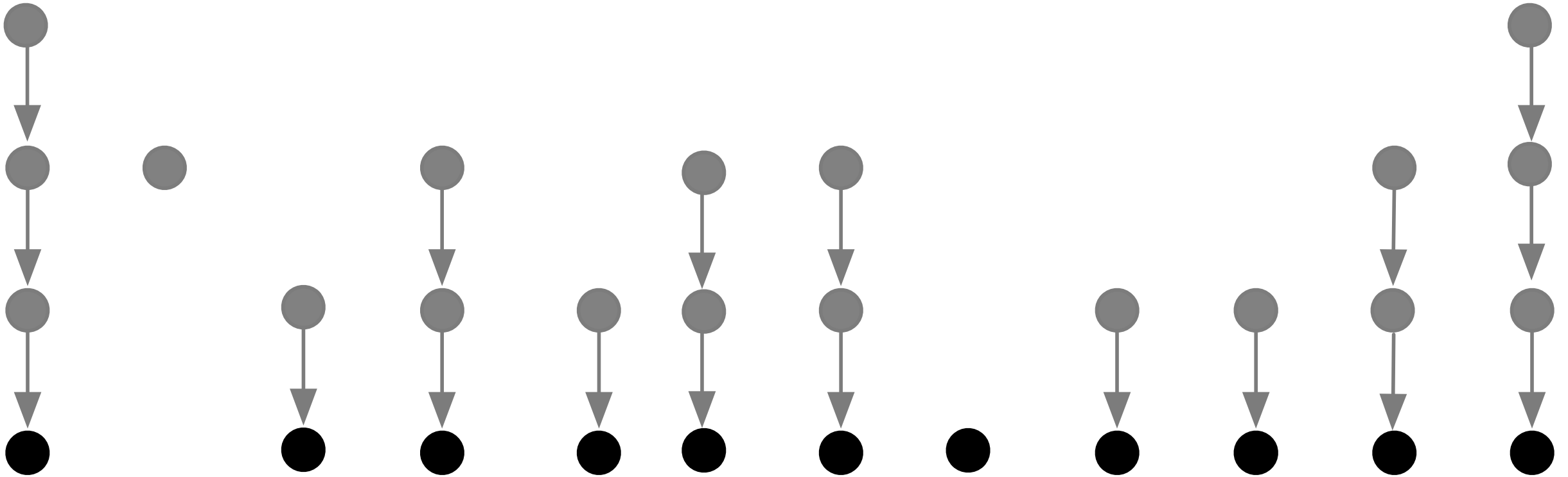

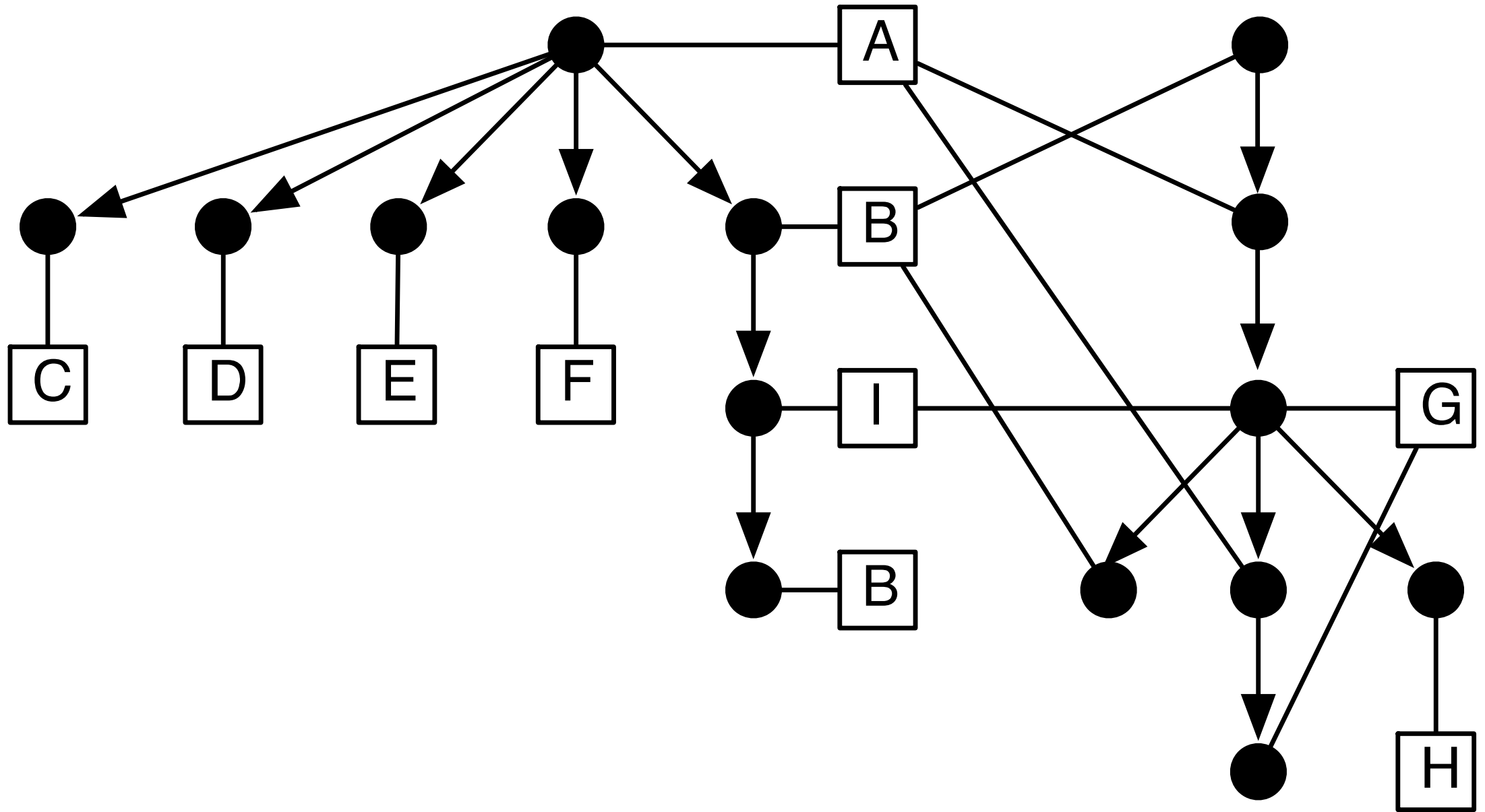

Steps

- Observe collective design systems
- Understand natural visibility
- Design new features
- Perform experiments
- Release features into the open
- ...with the goal of increasing innovation at the societal level

Post-human responsibilities

- Measure distances
 - Between designs
 - String edit, graph edit, spectrum
 - Between people
 - Through following
 - Through common editing of objects
- Recommend designs to modify and combine
 - Not too close, not too far







Are remix communities already post-human?



Save the planet and return
your name badge before you
leave (on Tuesday)

